

HALOGEN FREE KABLO KANALI  
KENDİNDEN KAPAKLI KANALLAR  
DIŞTAN KAPAKLI KANALLAR  
MEKS 100'LÜK SERİ PRİZ MONTAJ SETLERİ  
MEKSPLUS SERİSİ İÇTEN KAPAKLI KANALLAR  
SÜPÜRGELİK KABLO KANALLARI  
ZEMİN KABLO KANALLARI  
PROFİLLER  
KLİMA KANALI  
SİDEM SERİSİ KABLO KANALLAR  
HALOGEN FREE DELİKLİ KABLO KANALI  
DELİKLİ KABLO KANALI

HALOGEN FREE CABLE TRUNKING  
CABLE TRUNKING WITH INTRINSIC COVER  
CABLE TRUNKING WITH EXTERNAL COVER  
MEKS 100 SERIES PLUG SOCKET ASSEMBLY SETS  
MEKSPLUS SERIES WITH INTRINSIC COVER TRUNKING  
SKIRTING BOARD CABLE TRUNKING  
FLOOR CABLE TRUNKING  
PROFILES  
AIR CONDITIONING TRUNKING  
SIDEM SERIES CABLE TRUNKING  
HALOGEN FREE PERFORATED CABLE TRUNKING  
PERFORATED CABLE TRUNKING

SAYFA  
PAGE

04  
62

SANAYİ FİŞ - PRİZ GRUBU  
SİNYAL VE KUMANDA BUTONLARI  
ETANJ BUTON KUTULARI  
VİNÇ KUMANDA BUTONLARI  
SÜPER ETANJ RAKORLAR  
RAY KLEMENSLER  
SIKMALI TİP KABLO PAPUÇLARI  
SİRA KLEMENSLER  
RAYLAR, TOPRAKLAMA ÇUBUĞU VE BARALAR  
DÖNER LAMBA, FLAŞÖRLÜ LAMBA VE SİRENLER  
İKAZ LAMBALARI  
TERMOPLASTİK BUATLAR

PLUG - SOCKET GROUP  
SIGNAL AND CONTROL BUTTONS  
WATERPROOF BUTTON BOXES  
CRANE CONTROL BUTTONS  
SUPER WATERPROOF CABLE GLANDS  
RAIL TERMINAL BLOCKS  
CLAMPING TYPE CABLE TERMINAL LUGS  
WIRE CONNECTORS  
RAILS, GROUNDING ROD AND BUSBARS  
ROTATING BEACON, BLINKER BEACON AND SIRENS  
WARNING LIGHTS  
THERMOPLASTIC JUNCTION BOXES

SAYFA  
PAGE

63  
98

W OTOMAT KUTULARI  
TELEFON DAĞITIM KUTULARI VE AKSESUARLARI  
MODÜL BAĞLANTI ÇATISI  
ÇELİK SİRALLER PVC SİRALLER VE BORULAR  
HALOGEN FREE SİRALLER  
SİBOR SERİSİ BORULAR  
SUSTALAR VE BUAT KAPAKLARI  
BETON DUVAR KASALARI  
PLASTİK KASA VE BUATLAR  
KROŞELER  
PLASTİK DÜBELLER

FUSE BOXES  
TELEPHONE DISTRIBUTION BOXES (HUBS) and ACCESSORIES  
MODULE CONNECTION RACK  
STEEL SPIRALS PVC SPIRALS AND PIPES  
HALOGEN-FREE SPIRALS  
SİBOR SERIES PIPES  
CABLE PULLERS AND JUNCTION BOX COVERS  
CONCRETE WALL CASINGS  
PLASTIC CASINGS AND JUNCTION BOXES  
CABLE STRAPS  
PLASTIC DOWELS

SAYFA  
PAGE

99  
128

LED AYDINLATMA ARMATÜRLERİ  
PARABOLİK TAVAN ARMATÜRLERİ  
YÜKSEK TAVAN AYDINLATMA ARMATÜRLERİ  
BANT TİPİ ARMATÜRLER  
TAVAN ARMATÜRLERİ  
ACİL DURUM ARMATÜRLERİ

LED LIGHTING LUMINARIES  
PARABOLIC CEILING LIGHTING LUMINARIES  
HIGH CEILING LIGHTING LUMINAIRE  
BATTEN TYPE LUMINAIRE  
CEILING LIGHTING FIXTURE  
EMERGENCY LIGHTING

SAYFA  
PAGE

129  
161

# KABLO KANALLARI

CABLE TRUNKING





**KABLO KANALLARI**  
CABLE TRUNKING



**RENKLİ KABLO KANALLARI**  
COLORED CABLE TRUNKING

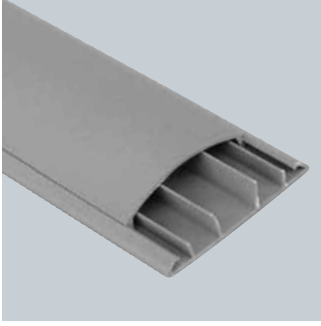

**ZEMİN KABLO KANALLARI**  
FLOOR CABLE TRUNKING

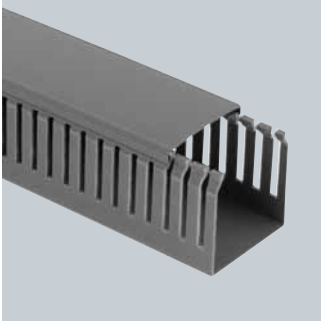

**DELİKLİ KABLO KANALLARI**  
SLOTED CABLE TRUNKING

# Kablo Kanallarımızın Teknik Özellikleri

## Technical Specifications For Cable Trunking

  
Halogen Free  
Alev Yaymayan  
Nonflammable!



Ultraviyole ışınlarına  
karşı dayanıklıdır.  
Resistance to  
UV Light



Asit buharına  
dayanıktır  
Resistance to  
acidic vapor



Elektriksel yalıtım  
özellğine sahiptir  
Electrically  
insulated



Daha pratik ve kolay montaj  
için tüm kanallarımız çift  
tarafli yapışkanlı bant ile  
kullanılabilir

Adhesive models  
are easy to install

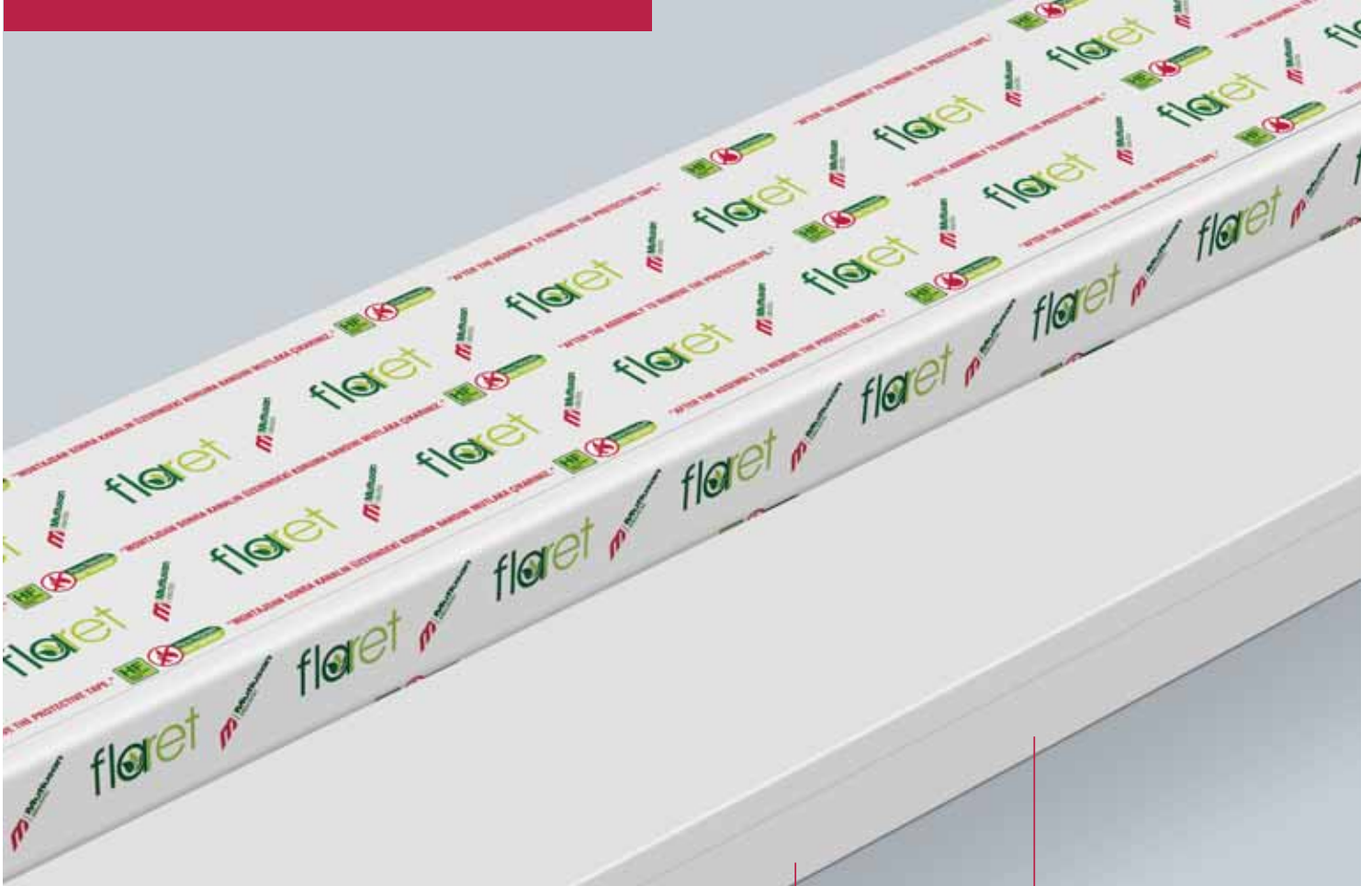

**Darbelerle dayanıklıdır.**

Shock Resistance



**İstenilen renkte boyanabilir**

Can be painted to desired color!

**+60°-25°**

**Aşırı soğuğa ve sığağa karşı dayanıklı**

Resistant to extreme cold and heat

**IP4X**

**Katı yabancı maddelerin girişine karşı koruma**

Protection against ingress of solid foreign substances



**ULUSLARARASI KALİTE NORMATLARINA UYGUN ÜRETİM!**

MUTLUSAN PLASTİK, kablo kanal kalitesini henüz üretim bandından GİRİŞ - PROSES - SON KONTROL ve yüksek teknoloji ürünü TEST CİHAZLARI ile donatılmış LABORATUVAR TESTLERİ ile garanti altına alır.

PRODUCTION COMPLYING WITH INTERNATIONAL QUALITY STANDARDS! MUTLUSAN PLASTİK assures the quality of the cable trunking through INPUT-PROCESS-FINAL CONTROL procedure and LABORATORY TESTS equipped with state-of-the-art TEST EQUIPMENT implemented at the plant when the products are still on the production line.



# HALOGEN FREE KABLO KANALI HALOGEN FREE CABLE TRUNKING



flaret



Flame Retardant  
Alev Yaymayan



Ürün Kodu	Product Code	001 060 04025 20 00
Ambalaj Şekli	Packing Type	Kutu - Box
Adet / m	Quantity / m	20 m
Ağırlık	Weight	17.700 kg
m <sup>3</sup> /	Volume	0.12022

#### AKSESUARLAR - ACCESSORIES

Kod Code	Ürün Product	Adet Quantity	Ağırlık Weight	m <sup>3</sup> Volume
001 039 040025 11 00	İç Köşe Internal Corner	24	0.354 kg	0.01044
001 040 040025 11 00	Dış Köşe External Corner	30	0.691 kg	0.00272
001 041 040025 11 00	T Köşe T Corner	18	0.345 kg	0.00731
001 042 040025 11 00	90° L Köşe 90° L Corner	24	0.376 kg	0.00272
001 043 040025 11 00	Ek Parça Connector	70	0.283 kg	0.00728
001 044 040025 11 00	Uç Tapa Blind Cap	25	0.152 kg	0.00128



Ürün Kodu	Product Code	001 060 100050 20 00
Ambalaj Şekli	Packing Type	Kutu - Box
Adet / m	Quantity / m	20 m
Ağırlık	Weight	17.700 kg
m <sup>3</sup> /	Volume	0.12022

#### AKSESUARLAR - ACCESSORIES

Kod Code	Ürün Product	Adet Quantity	Ağırlık Weight	m <sup>3</sup> Volume
001 061 100050 20 00	Ara Bölme Partition	150 m	20.400 kg	0.054
001 039 100050 11 00	İç Köşe Hareketli Internal Corner Live	12	0.583 kg	0.01045
001 040 100050 11 00	Dış Köşe Hareketli External Corner Live	8	0.182 kg	0.01045
001 041 100050 11 00	T Köşe T Corner	8	0.691 kg	0.01045
001 042 100050 11 00	90° L Köşe 90° L Corner	8	0.764 kg	0.01045
001 043 100050 11 00	Ek Parça Connector	12	1.056 kg	0.01045
001 44 100050 11 00	Uç Tapa Blind Cap	12	1.006 kg	0.01045
001 047 100001 11 00	PM Kasası 1'li Socket Assembly Frame Single	100	0.899	0.01050
001 047 100002 11 00	PM Kasası 2'li Socket Assembly Frame Double	20	0.5407 kg	0.01045
001 047 100003 11 00	PM Kasası 3'lü Socket Assembly Frame Triple	-	-	-

# KENDİNDEN KAPAKLI KANALLAR

## CABLE TRUNKING WITH INTRINSIC COVER



**Kendinden Yapışkanlı**  
Self-Adhesive

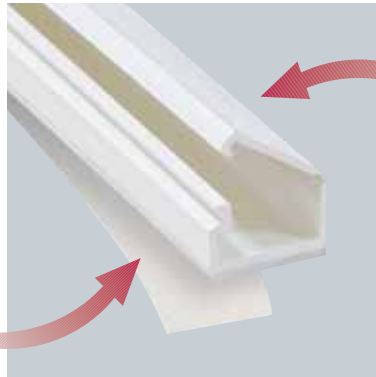

**Kendinden Kapaklı**  
Intrinsic Cover

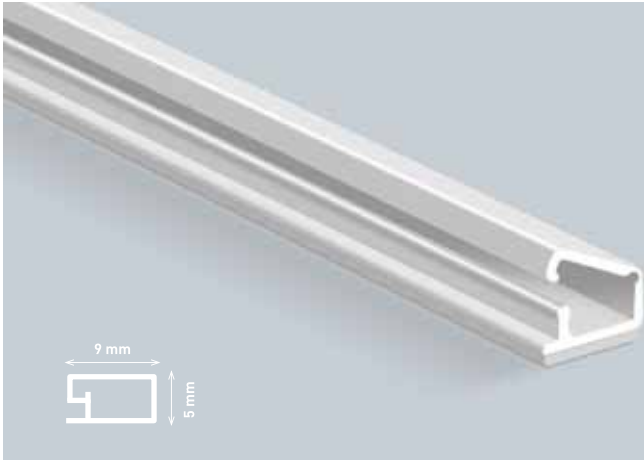

**9x5****Aksesuarsız**  
Without Accessories

Ürün Kodu	Product Code	<b>001 004 009005 20 00</b>
Ambalaj Şekli	Packing Type	Kutu - Box
Adet / m	Quantity / m	500 m
Ağırlık	Weight	18.4 kg
m <sup>3</sup> /	Volume	0.0435

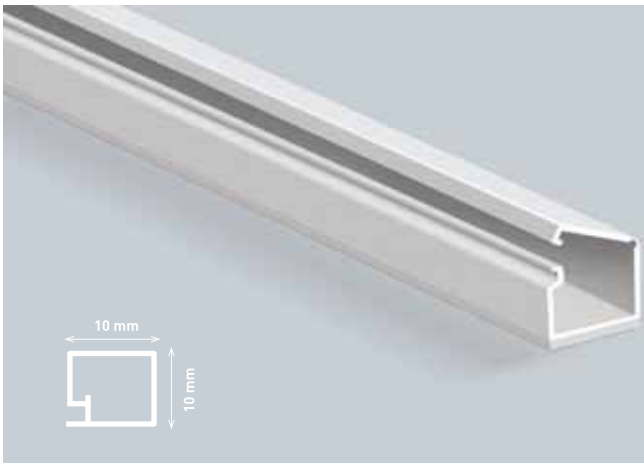
**10x10****Aksesuarsız**  
Without Accessories

Ürün Kodu	Product Code	<b>001 004 010010 20 00</b>
Ambalaj Şekli	Packing Type	Kutu - Box
Adet / m	Quantity / m	330 m
Ağırlık	Weight	12.36 kg
m <sup>3</sup> /	Volume	0.0400

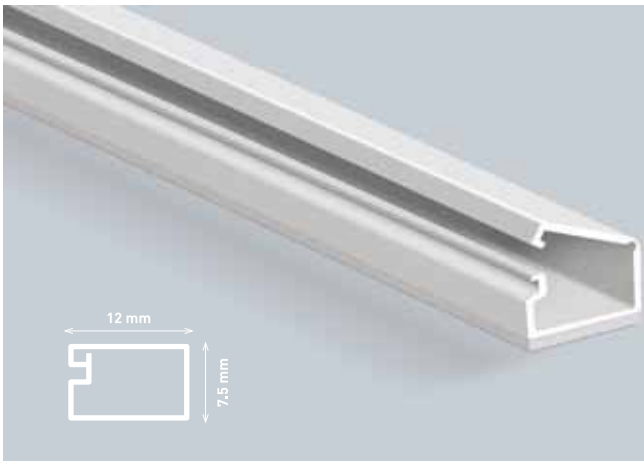
**12x7.5****Aksesuarsız**  
Without Accessories

Ürün Kodu	Product Code	<b>001 004 012007 20 00</b>
Ambalaj Şekli	Packing Type	Kutu - Box
Adet / m	Quantity / m	350 m
Ağırlık	Weight	18.34 kg
m <sup>3</sup> /	Volume	0.0511

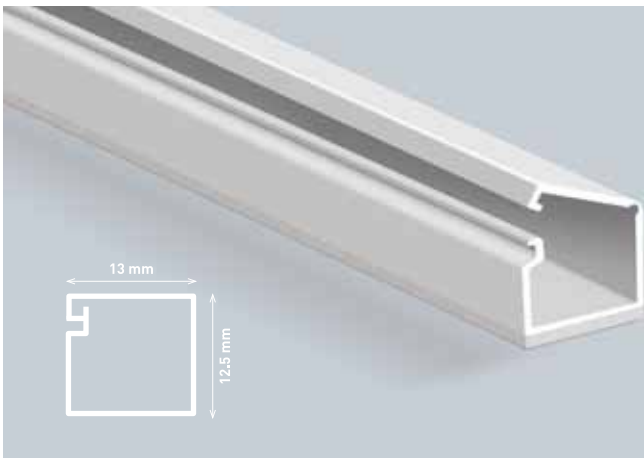
**13x12.5****Aksesuarsız**  
Without Accessories

Ürün Kodu	Product Code	<b>001 004 013012 20 00</b>
Ambalaj Şekli	Packing Type	Kutu - Box
Adet / m	Quantity / m	300 m
Ağırlık	Weight	23.49 kg
m <sup>3</sup> /	Volume	0.0768

# DIŐTAN KAPAKLI KANALLAR

## CABLE TRUNKING WITH EXTERNAL COVER

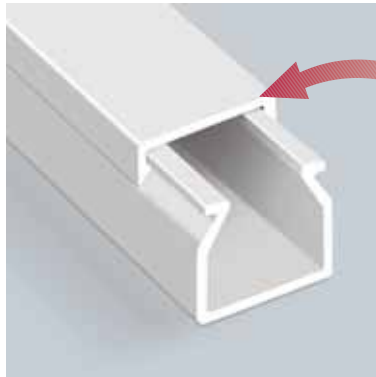

**Diőtan Kapaklı**  
External Cover



# 10x8

**Aksesuarsız**  
Without Accessories

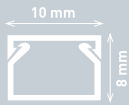

		<b>EKO</b> Serisi Series	<b>MEKS</b> Serisi Series
Ürün Kodu	Product Code	<b>001 014</b> <b>010008 20 00</b>	<b>001 002</b> <b>010008 20 00</b>
Ambalaj Şekli	Packing Type	Kutu - Box	Kutu - Box
Adet / m	Quantity / m	330 m	330 m
Ağırlık	Weight	15.85 kg	15.85 kg
m <sup>3</sup> /	Volume	0.04257	0.04257

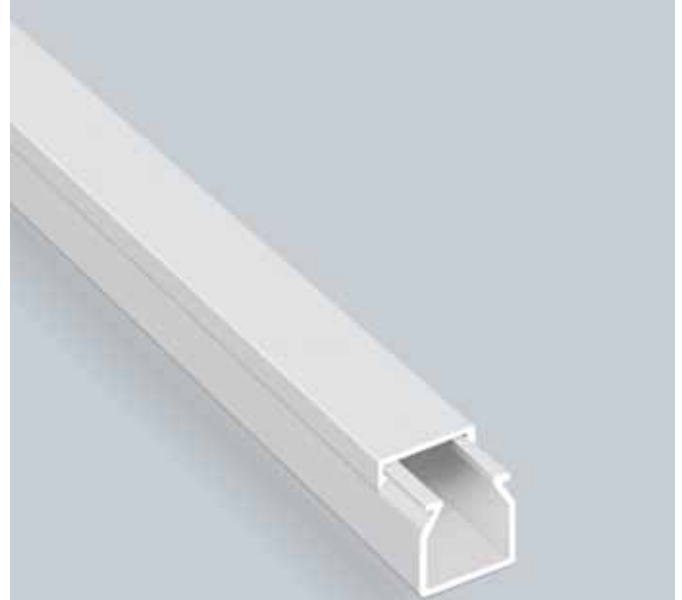

# 12x12

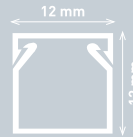

		<b>EKO</b> Serisi Series	<b>MEKS</b> Serisi Series	<b>CANALEX</b> Serisi Series
Ürün Kodu	Product Code	<b>001 014</b> <b>012012 20 00</b>	<b>001 002</b> <b>012012 20 00</b>	<b>001 156</b> <b>012012 20 00</b>
Ambalaj Şekli	Packing Type	Kutu - Box	Kutu - Box	Kutu - Box
Adet / m	Quantity / m	250 m	250 m	250 m
Ağırlık	Weight	17.8 kg	17.8 kg	17.8 kg
m <sup>3</sup> /	Volume	0,053	0,053	0,053



## AKSESUARLAR - ACCESSORIES

	Kod Code	Ürün Product	Adet Quantity	Ağırlık Weight	m <sup>3</sup> Volume
	<b>001 039</b> <b>012012 00 00</b>	İç Köşe Internal Corner	60	0.127 kg	0.00126
	<b>001 040</b> <b>012012 00 00</b>	Dış Köşe External Corner	60	0.170 kg	0.00126
	<b>001 041</b> <b>012012 00 00</b>	T Köşe T Corner	60	0.145 kg	0.00126
	<b>001 042</b> <b>012012 00 00</b>	90° L Köşe 90° L Corner	60	0.170 kg	0.00126
	<b>001 043</b> <b>012012 00 00</b>	Ek Parça Connector	100	0.141 kg	0.00120
	<b>001 044</b> <b>012012 00 00</b>	Uç Tapa Blind Cap	100	0.131 kg	0.0012

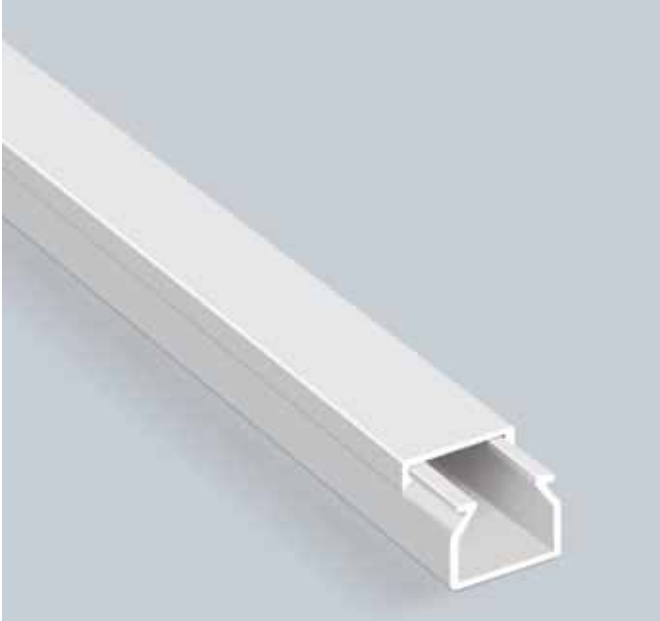

## 15x10

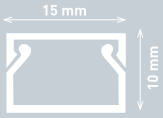

		<b>EKO</b> Serisi Series	<b>MEKS</b> Serisi Series	<b>CANALEX</b> Serisi Series
Ürün Kodu	Product Code	001 014 015010 20 00	001 002 015010 20 00	001 156 015010 20 00
Ambalaj Şekli	Packing Type	Kutu - Box	Kutu - Box	Kutu - Box
Adet / m	Quantity / m	250 m	250 m	250 m
Ağırlık	Weight	19.8 kg	19.8 kg	15.8 kg
m <sup>3</sup> /	Volume	0,053	0,053	0,053

### AKSESUARLAR - ACCESSORIES

	Kod Code	Ürün Product	Adet Quantity	Ağırlık Weight	m <sup>3</sup> Volume
	001 039 015010 00 00	İç Köşe Internal Corner	60	0.133 kg	0.006
	001 040 015010 00 00	Dış Köşe External Corner	60	0.176 kg	0.00264
	001 041 015010 00 00	T Köşe T Corner	60	0.230 kg	0.00264
	001 042 015010 00 00	90° L Köşe 90° L Corner	60	0.176 kg	0.00264
	001 043 015010 00 00	Ek Parça Connector	100	0.162 kg	0.00260
	001 044 015010 00 00	Uç Tapa Blind Cap	100	0.152 kg	0.0026

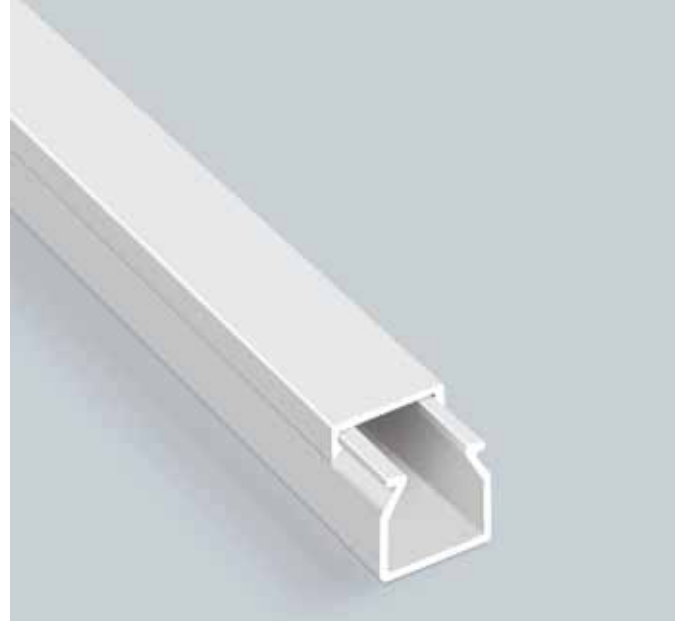

## 15x15

**Aksesuarsız**  
Without Accessories

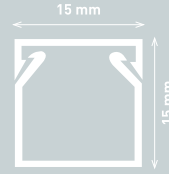

		<b>EKO</b> Serisi Series	<b>MEKS</b> Serisi Series
Ürün Kodu	Product Code	001 014 015015 20 00	001 002 015015 20 00
Ambalaj Şekli	Packing Type	Kutu - Box	Kutu - Box
Adet / m	Quantity / m	250 m	250 m
Ağırlık	Weight	23 kg.	23 kg.
m <sup>3</sup> /	Volume	0.085	0.085







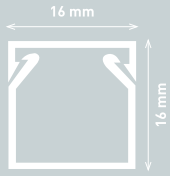



# 16x16



		<b>EKO</b> Serisi Series	<b>MEKS</b> Serisi Series	<b>CANALEX</b> Serisi Series
Ürün Kodu	Product Code	<b>001 014</b> <b>016016 20 00</b>	<b>001 002</b> <b>016016 20 00</b>	<b>001 156</b> <b>016016 20 00</b>
Ambalaj Şekli	Packing Type	Kutu - Box	Kutu - Box	Kutu - Box
Adet / m	Quantity / m	250 m	250 m	250 m
Ağırlık	Weight	27.39 kg	27.39 kg	20.64 kg
m <sup>3</sup> /	Volume	0,07125	0,07125	0,07125

### AKSESUARLAR - ACCESSORIES

	Kod Code	Ürün Product	Adet Quantity	Ağırlık Weight	m <sup>3</sup> Volume
	<b>001 039</b> <b>016016 00 00</b>	İç Köşe Internal Corner	60	0.158 kg	0.0078
	<b>001 040</b> <b>016016 00 00</b>	Dış Köşe External Corner	60	0.188 kg	0.00294
	<b>001 041</b> <b>016016 00 00</b>	T Köşe T Corner	60	0.176 kg	0.00294
	<b>001 042</b> <b>016016 00 00</b>	90° L Köşe 90° L Corner	60	0.242 kg	0.00294
	<b>001 043</b> <b>016016 00 00</b>	Ek Parça Connector	100	0.192 kg	0.0029
	<b>001 044</b> <b>016016 00 00</b>	Uç Tapa Blind Cap	100	0.182 kg	0.0029





# 20x10



		<b>EKO</b> Serisi Series	<b>MEKS</b> Serisi Series	<b>CANALEX</b> Serisi Series
Ürün Kodu	Product Code	<b>001 014</b> <b>020010 20 00</b>	<b>001 002</b> <b>020010 20 00</b>	<b>001 156</b> <b>020010 20 00</b>
Ambalaj Şekli	Packing Type	Kutu - Box	Kutu - Box	Kutu - Box
Adet / m	Quantity / m	200 m	200 m	200 m
Ağırlık	Weight	18.65 kg	18.65 kg	16.65 kg
m <sup>3</sup> /	Volume	0,0502	0,0502	0,0502

### AKSESUARLAR - ACCESSORIES

	Kod Code	Ürün Product	Adet Quantity	Ağırlık Weight	m <sup>3</sup> Volume
	<b>001 039</b> <b>020010 00 00</b>	İç Köşe Internal Corner	60	0.164 kg	0.00126
	<b>001 040</b> <b>020010 00 00</b>	Dış Köşe External Corner	60	0.170 kg	0.00126
	<b>001 041</b> <b>020010 00 00</b>	T Köşe T Corner	60	0.139 kg	0.00123
	<b>001 042</b> <b>020010 00 00</b>	90° L Köşe 90° L Corner	60	0.212 kg	0.00125
	<b>001 043</b> <b>020010 00 00</b>	Ek Parça Connector	100	0.162 kg	0.00120
	<b>001 044</b> <b>020010 00 00</b>	Uç Tapa Blind Cap	100	0.152 kg	0.0012

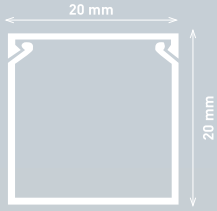

**20x20**Aksesuarsız  
Without Accessories**EKO** Serisi Series**MEKS** Serisi Series

Ürün Kodu	Product Code	<b>001 014</b> <b>020020 20 00</b>	<b>001 002</b> <b>020020 20 00</b>
Ambalaj Şekli	Packing Type	Kutu - Box	Kutu - Box
Adet / m	Quantity / m	144 m	144 m
Ağırlık	Weight	19.16 kg	19.16 kg
m <sup>3</sup> /	Volume	0.07128	0.07128

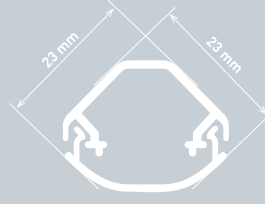
**23x23**Tavan Köşe Kanalı  
Ceiling Corner Trunking**MEKS** Serisi Series

Ürün Kodu	Product Code	<b>001 002 023023 20 00</b>
Ambalaj Şekli	Packing Type	Kutu - Box
Adet / m	Quantity / m	120 m
Ağırlık	Weight	23.94 kg
m <sup>3</sup> /	Volume	0.07536

**AKSESUARLAR - ACCESSORIES**

Kod Code	Ürün Product	Adet Quantity	Ağırlık Weight	m <sup>3</sup> Volume
 <b>001 039</b> <b>023023 00 00</b>	İç Köşe Internal Corner	1	0.013 kg	0.00014
 <b>001 040</b> <b>023023 00 00</b>	Dış Köşe External Corner	1	0.013 kg	0.00014
 <b>001 041</b> <b>023023 00 00</b>	T Köşe T Corner	60	0.792 kg	0.00832
 <b>001 042</b> <b>023023 00 00</b>	90° L Köşe 90° L Corner	60	0.255 kg	0.00293
 <b>001 043</b> <b>023023 00 00</b>	Ek Parça Connector	100	1.320 kg	0.01386
 <b>001 044</b> <b>023023 00 00</b>	Uç Tapa Blind Cap	100	0.167 kg	0.01386
 <b>001 050</b> <b>023023 00 00</b>	Kablo Taşıyıcı Cable Carrier	-	-	-





## 25x16

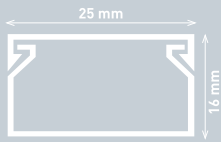

		<b>EKO</b> Seri Series	<b>MEKS</b> Seri Series	<b>CANALEX</b> Seri Series
Ürün Kodu	Product Code	<b>001 014</b> 025016 20 00	<b>001 002</b> 025016 20 00	<b>001 156</b> 025016 20 00
Ambalaj Şekli	Packing Type	Kutu - Box	Kutu - Box	Kutu - Box
Adet / m	Quantity / m	150 m	150 m	150 m
Ağırlık	Weight	20.66 kg	20.66 kg	18.11 kg
m <sup>3</sup> /	Volume	0,08235	0,08235	0,08235

### AKSESUARLAR - ACCESSORIES

	Kod Code	Ürün Product	Adet Quantity	Ağırlık Weight	m <sup>3</sup> Volume
	<b>001 013</b> 025016 00 00	İç Köşe Internal Corner	40	0.323 kg	0.00292
	<b>001 040</b> 025016 00 00	Dış Köşe External Corner	40	0.432 kg	0.00260
	<b>001 041</b> 025016 00 00	T Köşe T Corner	30	0.324 kg	0.00260
	<b>001 042</b> 025016 00 00	90° L Köşe 90° L Corner	50	0.434 kg	0.00260
	<b>001 043</b> 025016 00 00	Ek Parça Connector	100	0.212 kg	0.00260
	<b>001 044</b> 025016 00 00	Uç Tapa Blind Cap	100	0.182 kg	0.00260
	<b>001 047</b> 025016 00 00	PM Kasası 1'li Socket Assembly Frame Single	12	1.161 kg	0.00731



## 25x25

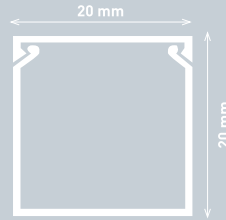

		<b>EKO</b> Seri Series	<b>MEKS</b> Seri Series	<b>CANALEX</b> Seri Series
Ürün Kodu	Product Code	<b>001 014</b> 025025 20 00	<b>001 002</b> 025025 20 00	<b>001 156</b> 025025 20 00
Ambalaj Şekli	Packing Type	Kutu - Box	Kutu - Box	Kutu - Box
Adet / m	Quantity / m	100 m	100 m	100 m
Ağırlık	Weight	20.16 kg	20.16 kg	17.36 kg
m <sup>3</sup> /	Volume	0,07820	0,07820	0,7820

### AKSESUARLAR - ACCESSORIES

	Kod Code	Ürün Product	Adet Quantity	Ağırlık Weight	m <sup>3</sup> Volume
	<b>001 013</b> 025025 00 00	İç Köşe Internal Corner	40	0.343 kg	0.00292
	<b>001 040</b> 025025 00 00	Dış Köşe External Corner	40	0.448 kg	0.00260
	<b>001 041</b> 025025 00 00	T Köşe T Corner	30	0.327 kg	0.00260
	<b>001 042</b> 025025 00 00	90° L Köşe 90° L Corner	50	0.448 kg	0.00260
	<b>001 043</b> 025025 00 00	Ek Parça Connector	100	0.126 kg	0.00260
	<b>001 044</b> 025025 00 00	Uç Tapa Blind Cap	100	0.263 kg	0.00260
	<b>001 047</b> 025025 00 00	PM Kasası 1'li Socket Assembly Frame Single	12	1.161 kg	0.00731

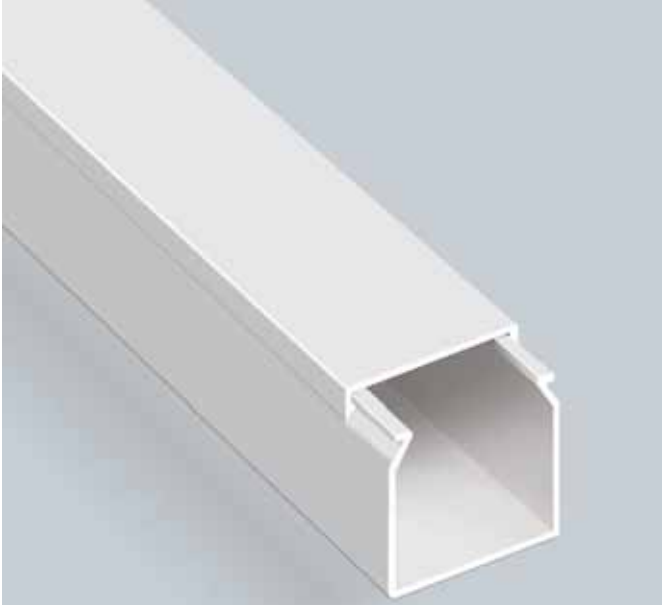
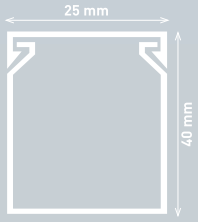
**25x40****Aksesuarsız**  
Without Accessories

		<b>EKO</b> Serisi Series	<b>MEKS</b> Serisi Series
Ürün Kodu	Product Code	<b>001 014</b> <b>025040 20 00</b>	<b>001 002</b> <b>025040 20 00</b>
Ambalaj Şekli	Packing Type	Kutu - Box	Kutu - Box
Adet / m	Quantity / m	80 m	80 m
Ağırlık	Weight	24.843 kg	24.843 kg
m <sup>3</sup> /	Volume	0,09664	0,09664

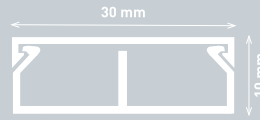
**30x10****Bölmeli**  
Partitioned

		<b>EKO</b> Serisi Series	<b>MEKS</b> Serisi Series
Ürün Kodu	Product Code	<b>001 014</b> <b>930010 20 00</b>	<b>001 002</b> <b>930010 20 00</b>
Ambalaj Şekli	Packing Type	Kutu - Box	Kutu - Box
Adet / m	Quantity / m	140 m	140 m
Ağırlık	Weight	19.25 kg	19.25 kg
m <sup>3</sup> /	Volume	0,05026	0,05026

**AKSESUARLAR - ACCESSORIES**

	Kod Code	Ürün Product	Adet Quantity	Ağırlık Weight	m <sup>3</sup> Volume
	<b>001 039</b> <b>030010 00 00</b>	İç Köşe Internal Corner	50	0.414 kg	0.00295
	<b>001 040</b> <b>030010 00 00</b>	Dış Köşe External Corner	50	0.419 kg	0.00260
	<b>001 041</b> <b>030010 00 00</b>	T Köşe T Corner	40	0.420 kg	0.00260
	<b>001 042</b> <b>030010 00 00</b>	90° L Köşe 90° L Corner	50	0.419 kg	0.00260
	<b>001 043</b> <b>030025 00 00</b>	Ek Parça Connector	100	0.202 kg	0.00260
	<b>001 044</b> <b>030025 00 00</b>	Uç Tapa Blind Cap	100	0.202 kg	0.00260

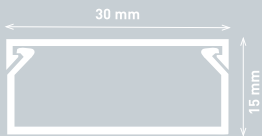
**30x15****Aksesuarsız**  
Without Accessories

		<b>EKO</b> Seri Series	<b>MEKS</b> Seri Series
Ürün Kodu	Product Code	<b>001 014</b> <b>030015 20 00</b>	<b>001 002</b> <b>030015 20 00</b>
Ambalaj Şekli	Packing Type	Kutu - Box	Kutu - Box
Adet / m	Quantity / m	140 m	140 m
Ağırlık	Weight	21.84 kg	21.84 kg
m <sup>3</sup> /	Volume	0,0089	0,0089

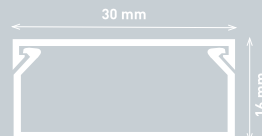
**30x16**

		<b>EKO</b> Seri Series	<b>MEKS</b> Seri Series	<b>CANALEX</b> Seri Series
Ürün Kodu	Product Code	<b>001 014</b> <b>030016 20 00</b>	<b>001 002</b> <b>030016 20 00</b>	<b>001 156</b> <b>030016 20 00</b>
Ambalaj Şekli	Packing Type	Kutu - Box	Kutu - Box	Kutu - Box
Adet / m	Quantity / m	140 m	140 m	140 m
Ağırlık	Weight	21,46 kg	21,46 kg	21,46 kg
m <sup>3</sup> /	Volume	0,07532	0,07532	0,07532

**AKSESUARLAR - ACCESSORIES**

	Kod Code	Ürün Product	Adet Quantity	Ağırlık Weight	m <sup>3</sup> Volume
	<b>001 013</b> <b>030016 00 00</b>	İç Köşe Internal Corner	35	0,350 kg	0,00294
	<b>001 040</b> <b>030016 00 00</b>	Dış Köşe External Corner	48	0,412 kg	0,00260
	<b>001 041</b> <b>030016 00 00</b>	T Köşe T Corner	40	0,497 kg	0,00260
	<b>001 042</b> <b>030016 00 00</b>	90° L Köşe 90° L Corner	50	0,475 kg	0,00260
	<b>001 043</b> <b>030025 00 00</b>	Ek Parça Connector	100	0,232 kg	0,0014
	<b>001 044</b> <b>030025 00 00</b>	Uç Tapa Blind Cap	100	0,303 kg	0,00260
	<b>001 047</b> <b>030016 00 00</b>	PM Kasası 1'li Socket Assembly Frame Single	12	1,161 kg	0,00731

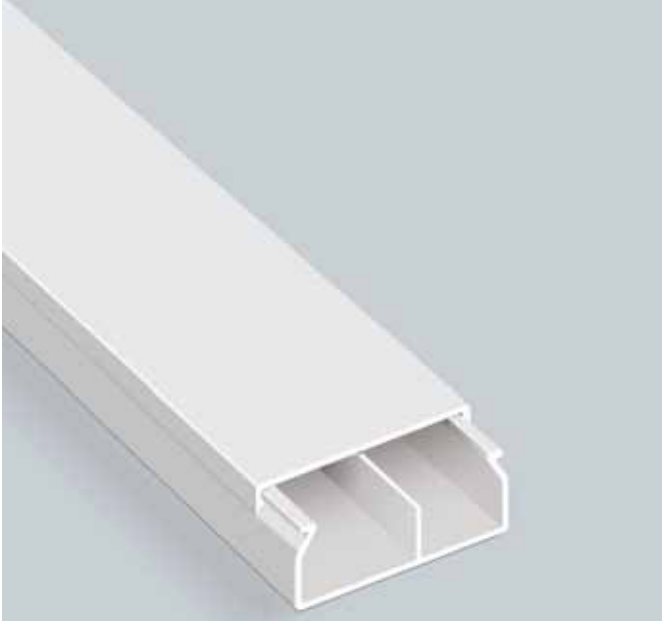
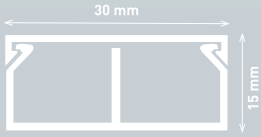
**30x16****Bölmeli**  
Partitioned

		<b>EKO</b> Serisi Series	<b>MEKS</b> Serisi Series
Ürün Kodu	Product Code	<b>001 014</b> <b>030015 20 00</b>	<b>001 002</b> <b>030015 20 00</b>
Ambalaj Şekli	Packing Type	Kutu - Box	Kutu - Box
Adet / m	Quantity / m	140 m	140 m
Ağırlık	Weight	22.86 kg	22.86 kg
m <sup>3</sup> /	Volume	0,07812	0,07812

**AKSESUARLAR - ACCESSORIES**

	Kod Code	Ürün Product	Adet Quantity	Ağırlık Weight	m <sup>3</sup> Volume
	<b>001 013</b> <b>030016 00 00</b>	İç Köşe Internal Corner	35	0.350 kg	0,00294
	<b>001 040</b> <b>030016 00 00</b>	Dış Köşe External Corner	48	0.412 kg	0,00260
	<b>001 041</b> <b>030016 00 00</b>	T Köşe T Corner	40	0.497 kg	0,00260
	<b>001 042</b> <b>030016 00 00</b>	90° L Köşe 90° L Corner	50	0.475 kg	0,00260
	<b>001 043</b> <b>030025 00 00</b>	Ek Parça Connector	100	0.232 kg	0,0014
	<b>001 044</b> <b>030025 00 00</b>	Uç Tapa Blind Cap	100	0.303 kg	0,00260
	<b>001 047</b> <b>030016 00 00</b>	PM Kasası 1'li Socket Assembly Frame Single	12	1.161 kg	0,00731

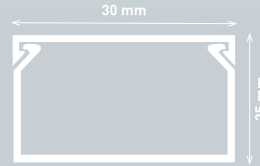
**30x25**

		<b>EKO</b> Serisi Series	<b>MEKS</b> Serisi Series
Ürün Kodu	Product Code	<b>001 014</b> <b>030025 20 00</b>	<b>001 002</b> <b>030025 20 00</b>
Ambalaj Şekli	Packing Type	Kutu - Box	Kutu - Box
Adet / m	Quantity / m	80 m	80 m
Ağırlık	Weight	16.34 kg	16.34 kg
m <sup>3</sup> /	Volume	0,07256	0,07256

**AKSESUARLAR - ACCESSORIES**

	Kod Code	Ürün Product	Adet Quantity	Ağırlık Weight	m <sup>3</sup> Volume
	<b>001 039</b> <b>030025 00 00</b>	İç Köşe Internal Corner	32	0.401 kg	0,00291
	<b>001 040</b> <b>030025 00 00</b>	Dış Köşe External Corner	30	0.470 kg	0,00260
	<b>001 041</b> <b>030025 00 00</b>	T Köşe T Corner	24	0.381 kg	0,00260
	<b>001 042</b> <b>030025 00 00</b>	90° L Köşe 90° L Corner	30	0.355 kg	0,00260
	<b>001 043</b> <b>030025 00 00</b>	Ek Parça Connector	100	0.263kg	0,00260
	<b>001 044</b> <b>030025 00 00</b>	Uç Tapa Blind Cap	100	0.364 kg	0,00260
	<b>001 047</b> <b>017421 00 00</b>	PM Kasası 1'li Socket Assembly Frame Single	12	1.161 kg	0,00731

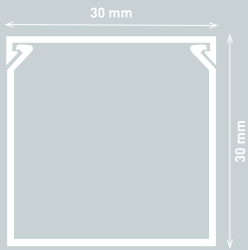

**30x30****Aksesuarsız**  
Without Accessories

Ürün Kodu	Product Code	<b>EKO</b> Serisi Series	<b>MEKS</b> Serisi Series
		<b>001 014</b> <b>030030 20 00</b>	<b>001 002</b> <b>030030 20 00</b>
Ambalaj Şekli	Packing Type	Kutu - Box	Kutu - Box
Adet / m	Quantity / m	80 m	80 m
Ağırlık	Weight	19.24 kg	19.24 kg
m <sup>3</sup> /	Volume	0,032	0,032

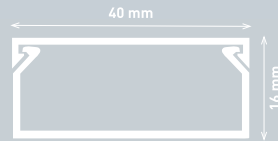
**40x16**

Ürün Kodu	Product Code	<b>EKO</b> Serisi Series	<b>MEKS</b> Serisi Series	<b>CANALEX</b> Serisi Series
		<b>001 014</b> <b>040016 20 00</b>	<b>001 002</b> <b>040016 20 00</b>	<b>001 156</b> <b>040016 20 00</b>
Ambalaj Şekli	Packing Type	Kutu - Box	Kutu - Box	Kutu - Box
Adet / m	Quantity / m	100 m	100 m	100 m
Ağırlık	Weight	20.16 kg	20.16 kg	17.66 kg
m <sup>3</sup> /	Volume	0,08090	0,08090	0,08090

**AKSESUARLAR - ACCESSORIES**

Kod Code	Ürün Product	Adet Quantity	Ağırlık Weight	m <sup>3</sup> Volume
<b>001 039</b> <b>040016 00 00</b>	İç Köşe Internal Corner	32	0,375 kg	0,00979
<b>001 040</b> <b>040016 00 00</b>	Dış Köşe External Corner	30	0,970 kg	0,00240
<b>001 041</b> <b>040016 00 00</b>	T Köşe T Corner	24	0,402 kg	0,00730
<b>001 042</b> <b>040016 00 00</b>	90° L Köşe 90° L Corner	34	0,446 kg	0,00730
<b>001 043</b> <b>040040 00 00</b>	Ek Parça Connector	100	0,404 kg	0,00730
<b>001 044</b> <b>040040 00 00</b>	Uç Tapa Blind Cap	25	0,093 kg	0,00730
<b>001 047</b> <b>040016 00 00</b>	PM Kasası 1'li Socket Assembly Frame Single	12	1,161 kg	0,00731

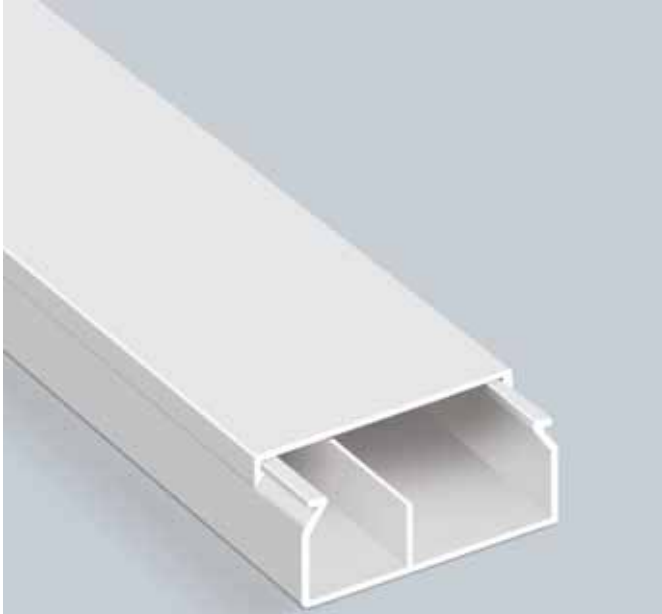

**40x16**

**Bölmeli**  
Partitioned



		<b>EKO</b> Serisi Series	<b>MEKS</b> Serisi Series
Ürün Kodu	Product Code	<b>001 014</b> <b>940016 20 00</b>	<b>001 002</b> <b>940016 20 00</b>
Ambalaj Şekli	Packing Type	Kutu - Box	Kutu - Box
Adet / m	Quantity / m	100 m	100 m
Ağırlık	Weight	23.16 kg	23.16 kg
m <sup>3</sup> /	Volume	0.0767	0.0767



**40x17**

**Tam Kapaklı - Full Cover**  
**Aksesuarsız - Without Accessories**



		<b>MEKS</b> Serisi Series
Ürün Kodu	Product Code	<b>001 002 040017 20 00</b>
Ambalaj Şekli	Packing Type	Kutu - Box
Adet / m	Quantity / m	100 m
Ağırlık	Weight	26.16 kg
m <sup>3</sup> /	Volume	0.0809

**AKSESUARLAR - ACCESSORIES**

	Kod Code	Ürün Product	Adet Quantity	Ağırlık Weight	m <sup>3</sup> Volume
	<b>001 039</b> <b>040016 00 00</b>	İç Köşe Internal Corner	32	0.375 kg	0.00979
	<b>001 040</b> <b>040016 00 00</b>	Dış Köşe External Corner	30	0.970 kg	0.00240
	<b>001 041</b> <b>040016 00 00</b>	T Köşe T Corner	24	0.402 kg	0.00730
	<b>001 042</b> <b>040016 00 00</b>	90° L Köşe 90° L Corner	34	0.446 kg	0.00730
	<b>001 043</b> <b>040040 00 00</b>	Ek Parça Connector	100	0.404 kg	0.00730
	<b>001 044</b> <b>040040 00 00</b>	Uç Tapa Blind Cap	25	0.093 kg	0.00730
	<b>001 047</b> <b>040016 00 00</b>	PM Kasası 1'li Socket Assembly Frame Single	12	1.161 kg	0.00731



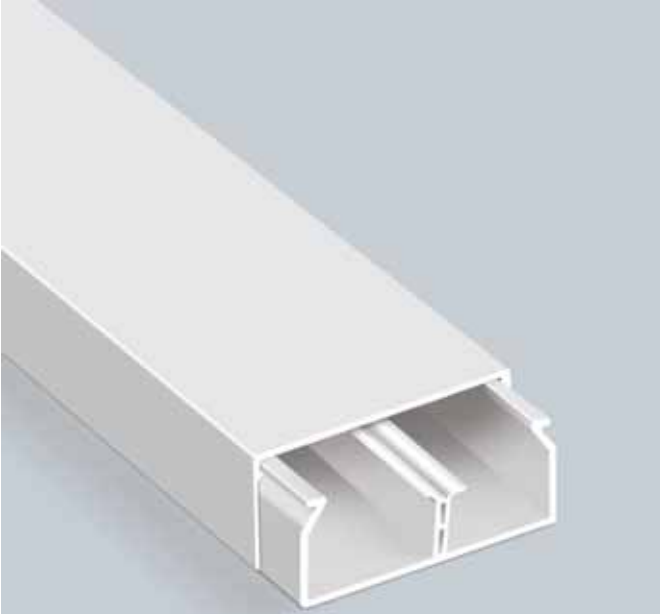

# 40x17

**Tam Kapaklı Bölmeli**  
Full Cover and Partitioned  
**Aksesuarsız**  
Without Accessories

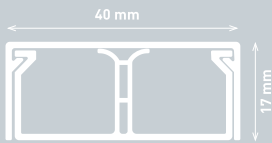

**MEKS**  
Serisi Series

Ürün Kodu	Product Code	001 002 940017 20 00
Ambalaj Şekli	Packing Type	Kutu - Box
Adet / m	Quantity / m	100 m
Ağırlık	Weight	26.16 kg
m <sup>3</sup> /	Volume	0.0809

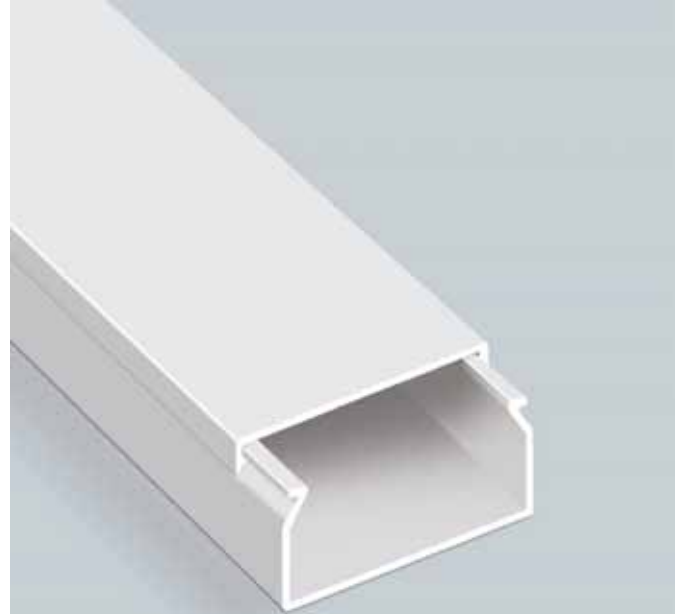

# 40x25

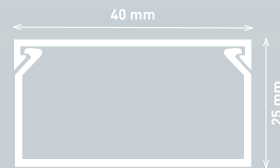

**EKO**  
Serisi Series

**MEKS**  
Serisi Series

**CANALEX**  
Serisi Series

Ürün Kodu	Product Code	001 014 040025 20 00	001 002 040025 20 00	001 156 040025 20 00
Ambalaj Şekli	Packing Type	Kutu - Box	Kutu - Box	Kutu - Box
Adet / m	Quantity / m	80 m	80 m	80 m
Ağırlık	Weight	22.043 kg	22.043 kg	17.243 kg
m <sup>3</sup> /	Volume	0,09592	0,09592	0,09592



## AKSESUARLAR - ACCESSORIES

Kod Code	Ürün Product	Adet Quantity	Ağırlık Weight	m <sup>3</sup> Volume
001 039 040025 00 00	İç Köşe Internal Corner	24	0.354 kg	0.01044
001 040 040025 00 00	Dış Köşe External Corner	30	0.691 kg	0.00272
001 041 040025 00 00	T Köşe T Corner	18	0.345 kg	0.00731
001 042 040025 00 00	90° L Köşe 90° L Corner	24	0.376 kg	0.00272
001 043 040040 00 00	Ek Parça Connector	70	0.283 kg	0.00728
001 044 040040 00 00	Uç Tapa Blind Cap	25	0.152 kg	0.00128
001 047 040025 00 00	PM Kasası 1'li Socket Assembly Frame Single	12	1.161 kg	0.00731

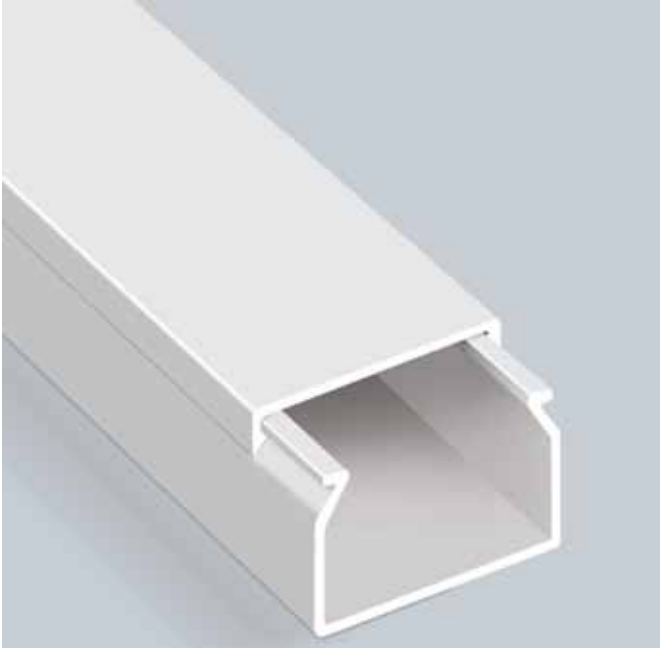

**40x40**

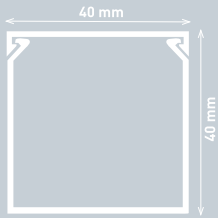

		<b>EKO</b> Serisi Series	<b>MEKS</b> Serisi Series	<b>CANALEX</b> Serisi Series
Ürün Kodu	Product Code	<b>001 014</b> <b>040040 20 00</b>	<b>001 002</b> <b>040040 20 00</b>	<b>001 156</b> <b>040040 20 00</b>
Ambalaj Şekli	Packing Type	Kutu - Box	Kutu - Box	Kutu - Box
Adet / m	Quantity / m	50 m	50 m	50 m
Ağırlık	Weight	16.743 kg	16.743 kg	15.743 kg
m <sup>3</sup> /	Volume	0,10230	0,10230	0,10230

**AKSESUARLAR - ACCESSORIES**

	Kod Code	Ürün Product	Adet Quantity	Ağırlık Weight	m <sup>3</sup> Volume
	<b>001 039</b> <b>040040 00 00</b>	İç Köşe Internal Corner	18	0.441 kg	0.010458
	<b>001 040</b> <b>040040 00 00</b>	Dış Köşe External Corner	10	0.290 kg	0.00272
	<b>001 041</b> <b>040040 00 00</b>	T Köşe T Corner	48	1.265 kg	0.0073
	<b>001 042</b> <b>040040 00 00</b>	90° L Köşe 90° L Corner	60	1.260 kg	0.0073
	<b>001 043</b> <b>040040 00 00</b>	Ek Parça Connector	100	0.434 kg	0.0073
	<b>001 044</b> <b>040040 00 00</b>	Uç Tapa Blind Cap	25	0.146 kg	0.0073

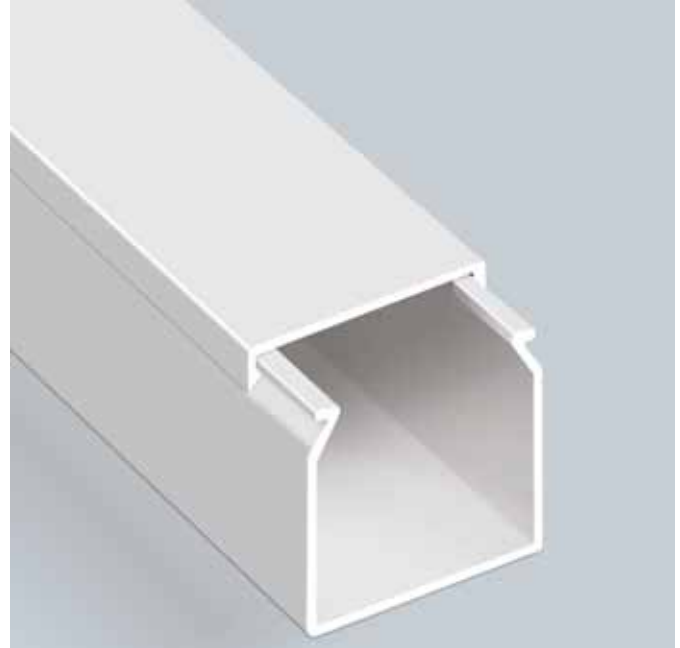

**40x60**

**Aksesuarsız**  
Without Accessories

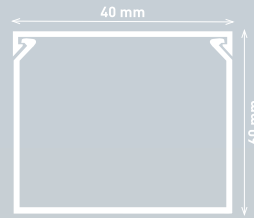

		<b>EKO</b> Serisi Series	<b>MEKS</b> Serisi Series
Ürün Kodu	Product Code	<b>001 014</b> <b>040060 20 00</b>	<b>001 002</b> <b>040060 20 00</b>
Ambalaj Şekli	Packing Type	Kutu - Box	Kutu - Box
Adet / m	Quantity / m	40 m	40 m
Ağırlık	Weight	21.518 kg	21.518 kg
m <sup>3</sup> /	Volume	0.11216	0.11216

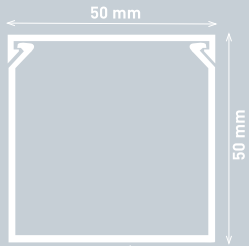

**50x50****Aksesuarsız**  
Without Accessories**EKO** Serisi Series

Ürün Kodu	Product Code	001 014 050050 20 00
Ambalaj Şekli	Packing Type	Kutu - Box
Adet / m	Quantity / m	30 m
Ağırlık	Weight	13.243 kg
m <sup>3</sup> /	Volume	0.09663

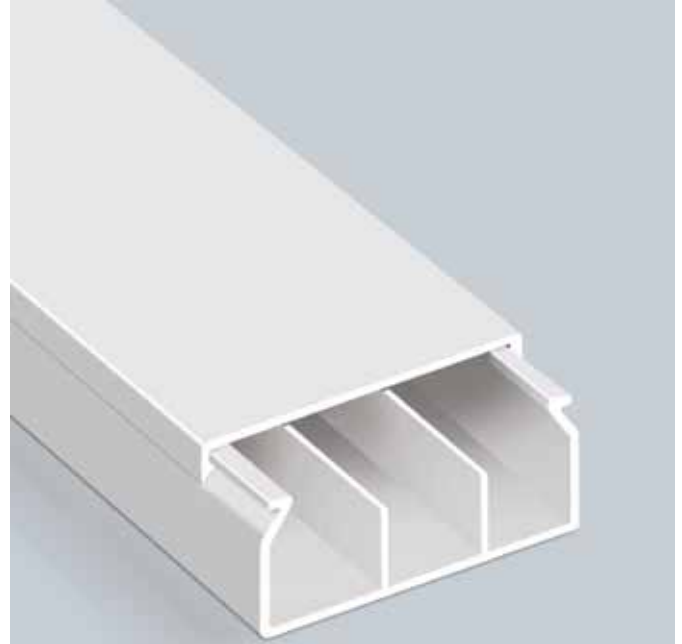
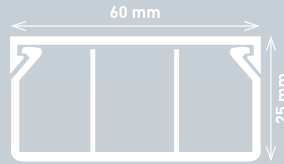
**60x25****Bölmeli**  
Partitioned**EKO** Serisi Series**MEKS** Serisi Series

Ürün Kodu	Product Code	001 014 960025 20 00	001 002 960025 20 00
Ambalaj Şekli	Packing Type	Kutu - Box	Kutu - Box
Adet / m	Quantity / m	40 m	40 m
Ağırlık	Weight	17.14 kg	17.14 kg
m <sup>3</sup> /	Volume	0.07264	0.07264

**AKSESUARLAR - ACCESSORIES**

Kod Code	Ürün Product	Adet Quantity	Ağırlık Weight	m <sup>3</sup> Volume
001 039 060025 00 00	İç Köşe Internal Corner	48	1.018 kg	0.00984
001 040 060025 00 00	Dış Köşe External Corner	72	1.454 kg	0.00984
001 041 060025 00 00	T Köşe T Corner	40	2.089 kg	0.00984
001 042 060025 00 00	90° L Köşe 90° L Corner	60	2.042 kg	0.00984
001 043 060060 00 00	Ek Parça Connector	60	0.455 kg	0.00272
001 044 060025 00 00	Uç Tapa Blind Cap	50	0.434 kg	0.00272
001 047 017421 00 00	PM Kasası 1'li Socket Assembly Frame Single	12	1.161 kg	0.00731





## 60x40



		<b>EKO</b> SeriŖi Series	<b>MEKS</b> SeriŖi Series	<b>CANALEX</b> SeriŖi Series
Ürün Kodu	Product Code	<b>001 014</b> <b>060040 20 00</b>	<b>001 002</b> <b>060040 20 00</b>	<b>001 156</b> <b>060040 20 00</b>
Ambalaj Ŗekli	Packing Type	Kutu - Box	Kutu - Box	Kutu - Box
Adet / m	Quantity / m	40 m	40 m	40 m
Ađırlık	Weight	21.118 kg	21.118 kg	15.518 kg
m <sup>3</sup> /	Volume	0,11084	0,11084	0,11084

### AKSESUARLAR - ACCESSORIES

	Kod Code	Ürün Product	Adet Quantity	Ađırlık Weight	m <sup>3</sup> Volume
	<b>001 039</b> <b>060040 00 00</b>	İç KöŖe Internal Corner	26	0.441 kg	0.00985
	<b>001 040</b> <b>060040 00 00</b>	DıŐ KöŖe External Corner	32	0.290 kg	0.01011
	<b>001 041</b> <b>060040 00 00</b>	T KöŖe T Corner	32	1.265 kg	0.00986
	<b>001 042</b> <b>060040 00 00</b>	90° L KöŖe 90° L Corner	40	1.260 kg	0.01011
	<b>001 043</b> <b>060060 00 00</b>	Ek Parça Connector	40	0.434 kg	0.00272
	<b>001 044</b> <b>060040 00 00</b>	Uç Tapa Blind Cap	50	0.146 kg	0.00272



## 60x60

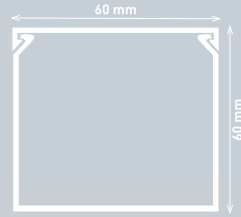

		<b>EKO</b> SeriŖi Series	<b>MEKS</b> SeriŖi Series	<b>CANALEX</b> SeriŖi Series
Ürün Kodu	Product Code	<b>001 014</b> <b>060060 20 00</b>	<b>001 002</b> <b>060060 20 00</b>	<b>001 156</b> <b>060060 20 00</b>
Ambalaj Ŗekli	Packing Type	Kutu - Box	Kutu - Box	Kutu - Box
Adet / m	Quantity / m	32 m	32 m	32 m
Ađırlık	Weight	20.957 kg	20.957 kg	18.717 kg
m <sup>3</sup> /	Volume	0,13590	0,13590	0,13590

### AKSESUARLAR - ACCESSORIES

	Kod Code	Ürün Product	Adet Quantity	Ađırlık Weight	m <sup>3</sup> Volume
	<b>001 039</b> <b>060060 01 00</b>	Hareketli İÇ KöŖe Internal Corner Live	16	0.441 kg	0.00939
	<b>001 040</b> <b>060060 01 00</b>	Hareketli DıŐ KöŖe External Corner Live	16	0.290 kg	0.01011
	<b>001 041</b> <b>060060 00 00</b>	T KöŖe T Corner	20	1.265 kg	0.01044
	<b>001 042</b> <b>060060 00 00</b>	90° L KöŖe 90° L Corner	24	1.260 kg	0.01044
	<b>001 043</b> <b>060060 00 00</b>	Ek Parça Connector	25	0.434 kg	0.01045
	<b>001 044</b> <b>060060 00 00</b>	Uç Tapa Blind Cap	30	0.146 kg	0.01044

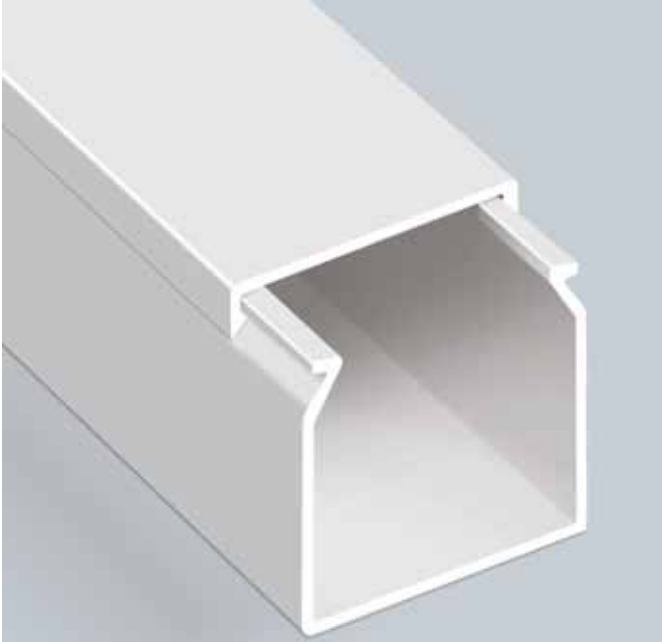
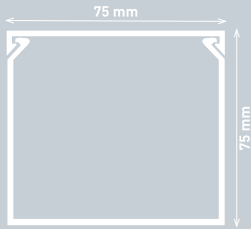



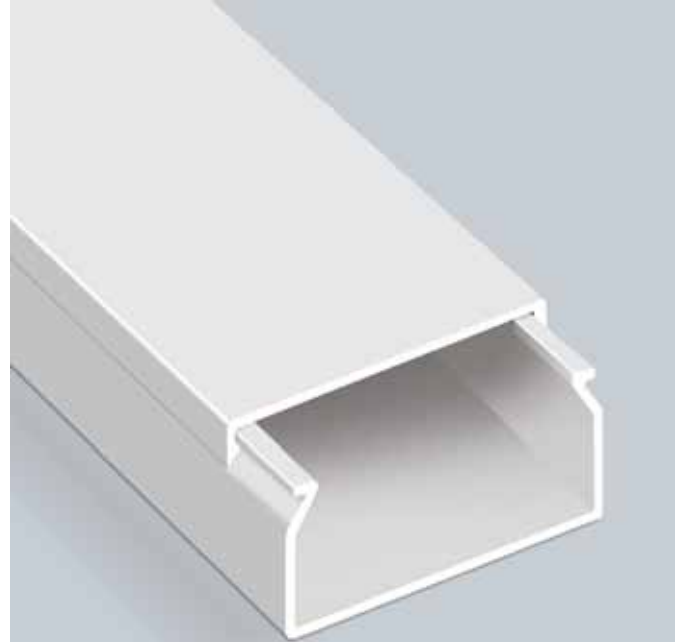

**75x75****Aksesuarsız**  
Without Accessories**EKO** Serisi Series

Ürün Kodu	Product Code	<b>001 014 075075 20 00</b>
Ambalaj Şekli	Packing Type	Kutu - Box
Adet / m	Quantity / m	28 m
Ağırlık	Weight	25.993
m <sup>3</sup> /	Volume	0.17357

**80x40****EKO** Serisi Series**MEKS** Serisi Series**CANALEX** Serisi Series

Ürün Kodu	Product Code	<b>001 014 060060 20 00</b>	<b>001 002 060060 20 00</b>	<b>001 156 060060 20 00</b>
Ambalaj Şekli	Packing Type	Kutu - Box	Kutu - Box	Kutu - Box
Adet / m	Quantity / m	30 m	30 m	30 m
Ağırlık	Weight	19.518 kg	19.518 kg	17.118 kg
m <sup>3</sup> /	Volume	0,11217	0,11217	0,11217

**AKSESUARLAR - ACCESSORIES**

Kod Code	Ürün Product	Adet Quantity	Ağırlık Weight	m <sup>3</sup> Volume
 <b>001 039 080040 00 00</b>	İç Köşe Internal Corner	18	0.441 kg	0.01046
 <b>001 040 080040 00 00</b>	Dış Köşe External Corner	8	0.290 kg	0.01046
 <b>001 041 080040 00 00</b>	T Köşe T Corner	12	1.265 kg	0.01046
 <b>001 042 080040 00 00</b>	90° L Köşe 90° L Corner	16	1.260 kg	0.01046
 <b>001 043 080040 00 00</b>	Ek Parça Connector	100	0.434 kg	0.01046
 <b>001 044 080040 00 00</b>	Uç Tapa Blind Cap	60	0.146 kg	0.01046



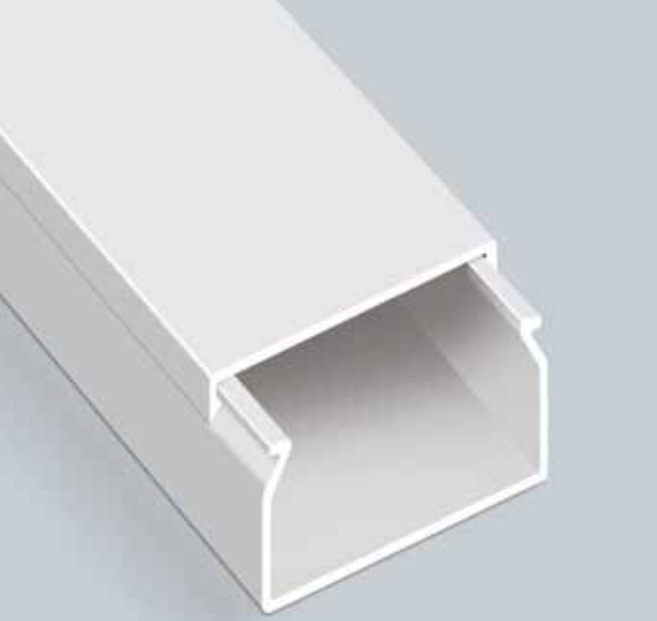

**80x60**

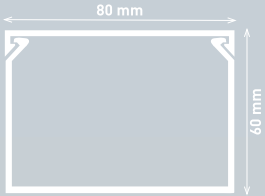

	<b>EKO</b> Serisi Series	<b>MEKS</b> Serisi Series	<b>CANALEX</b> Serisi Series
Ürün Kodu Product Code	<b>001 014</b> <b>080060 20 00</b>	<b>001 002</b> <b>080060 20 00</b>	<b>001 156</b> <b>080060 20 00</b>
Ambalaj Şekli Packing Type	Kutu - Box	Kutu - Box	Kutu - Box
Adet / m Quantity / m	24 m	24 m	24 m
Ağırlık Weight	18.557 kg	18.557 kg	16.157 kg
m <sup>3</sup> / Volume	0.13591	0.13591	0.13591

**AKSESUARLAR - ACCESSORIES**

	Kod Code	Ürün Product	Adet Quantity	Ağırlık Weight	m <sup>3</sup> Volume
	<b>001 039</b> <b>080060 00 00</b>	İç Köşe Internal Corner	18	0.441 kg	0.00939
	<b>001 040</b> <b>080060 00 00</b>	Dış Köşe External Corner	8	0.290 kg	0.01045
	<b>001 041</b> <b>080060 00 00</b>	T Köşe T Corner	8	1.265 kg	0.00809
	<b>001 042</b> <b>080060 00 00</b>	90° L Köşe 90° L Corner	10	1.260 kg	0.00842
	<b>001 043</b> <b>080060 00 00</b>	Ek Parça Connector	80	0.434 kg	0.01011
	<b>001 044</b> <b>080060 00 00</b>	Uç Tapa Blind Cap	48	0.146 kg	0.01046

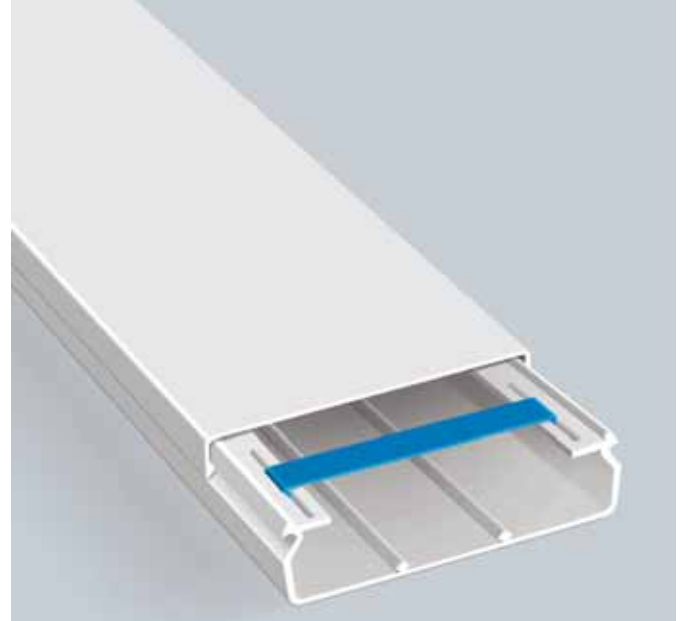

**100x36**

**Kilitleme Aparatı**  
With Locking Apparatus

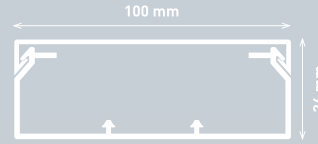

**MEKS**  
Serisi Series

Ürün Kodu Product Code	001 002 100036 20 00
Ambalaj Şekli Packing Type	Kutu - Box
Adet / m Quantity / m	30 m
Ağırlık Weight	31.307 kg
m <sup>3</sup> / Volume	0.13722

**AKSESUARLAR - ACCESSORIES**

	Kod Code	Ürün Product	Adet Quantity	Ağırlık Weight	m <sup>3</sup> Volume
	<b>001 013</b> <b>100036 00 00</b>	Ara Bölme Partition	200 m	20.400 kg	0.054
	<b>001 039</b> <b>100036 00 00</b>	İç Köşe Internal Corner	8	0.583 kg	0.01045
	<b>001 039</b> <b>100040 01 00</b>	İç Köşe Hareketli Internal Corner Live	8	0.182 kg	0.01045
	<b>001 040</b> <b>100040 00 00</b>	Dış Köşe External Corner	8	0.691 kg	0.01045
	<b>001 040</b> <b>100036 01 00</b>	Dış Köşe Hareketli External Corner Live	8	0.764 kg	0.01045
	<b>001 041</b> <b>100036 00 00</b>	T Köşe T Corner	12	1.056 kg	0.01045
	<b>001 042</b> <b>100036 00 00</b>	90° L Köşe 90° L Corner	12	1.006 kg	0.01045
	<b>001 043</b> <b>100060 00 00</b>	Ek Parça Connector	100	0.899	0.01050
	<b>001 044</b> <b>100060 00 00</b>	Uç Tapa Blind Cap	20	0.5407 kg	0.01045
	<b>001 050</b> <b>030004 00 00</b>	Kilitleme Aparatı Locking Apparatus	-	-	-

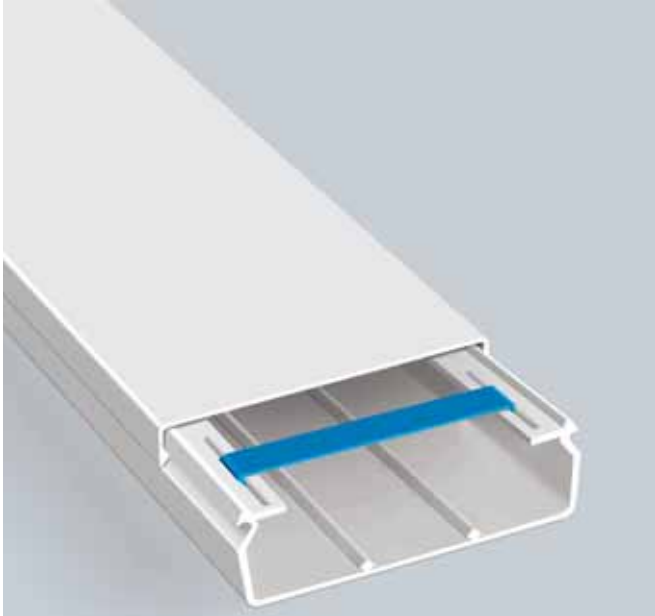
**100x40****Kilitleme Aparatı**  
With Locking Apparatus

		<b>EKO</b> Serisi Series	<b>MEKS</b> Serisi Series	<b>CANALEX</b> Serisi Series
Ürün Kodu	Product Code	001 014 100040 20 00	001 002 100040 20 00	001 156 100040 20 00
Ambalaj Şekli	Packing Type	Kutu - Box	Kutu - Box	Kutu - Box
Adet / m	Quantity / m	24 m	24 m	24 m
Ağırlık	Weight	21.678 kg	24.318 kg	17.118 kg
m <sup>3</sup> /	Volume	0.11348	0.11348	0.11348

**AKSESUARLAR - ACCESSORIES**

	Kod Code	Ürün Product	Adet Quantity	Ağırlık Weight	m <sup>3</sup> Volume
	001 013 100040 00 00	Ara Bölme Partition	200 m	21.050 kg	0.054
	001 039 100040 00 00	İç Köşe Internal Corner	8	0.606 kg	0.01045
	001 039 100040 01 00	İç Köşe Hareketli Internal Corner Live	8	0.206 kg	0.00939
	001 040 100040 00 00	Dış Köşe External Corner	8	0.743 kg	0.00787
	001 040 100040 01 00	Dış Köşe Hareketli External Corner Live	8	0.599 kg	0.00629
	001 041 100040 00 00	T Köşe T Corner	12	1.150 kg	0.01045
	001 042 100040 00 00	90° L Köşe 90° L Corner	12	1.036 kg	0.01045
	001 043 100060 00 00	Ek Parça Connector	100	0.899 kg	0.01050
	001 044 100060 00 00	Uç Tapa Blind Cap	20	0.228 kg	0.00272
	001 050 030004 00 00	Kilitleme Aparatı Locking Apparatus	-	-	-

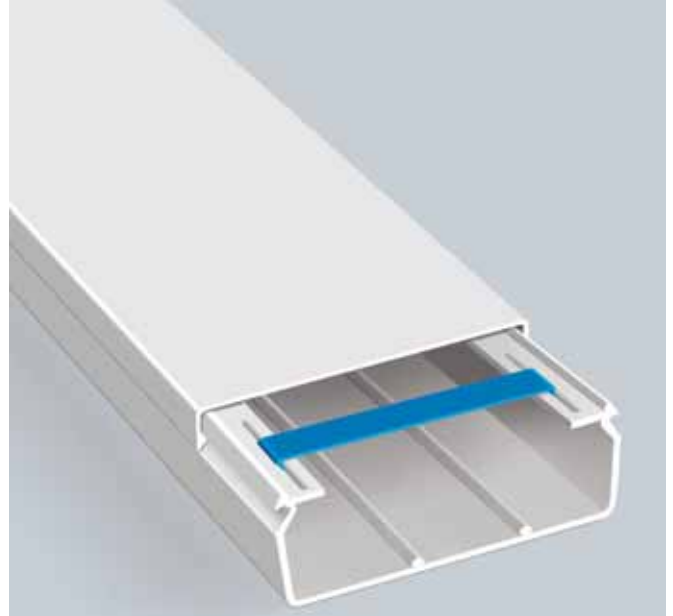
**100x48****Kilitleme Aparatı**  
With Locking Apparatus

		<b>MEKS</b> Serisi Series
Ürün Kodu	Product Code	001 002 100048 20 00
Ambalaj Şekli	Packing Type	Kutu - Box
Adet / m	Quantity / m	24 m
Ağırlık	Weight	25.757 kg
m <sup>3</sup> /	Volume	0.13591

**AKSESUARLAR - ACCESSORIES**

	Kod Code	Ürün Product	Adet Quantity	Ağırlık Weight	m <sup>3</sup> Volume
	001 013 100048 00 00	Ara Bölme Partition	150 m	19.61 kg	0.07965
	001 039 100048 00 00	İç Köşe Internal Corner	8	0.749 kg	0.01045
	001 039 100060 01 00	İç Köşe Hareketli Internal Corner Live	8	0.770 kg	0.01045
	001 040 100048 00 00	Dış Köşe External Corner	8	0.808 kg	0.01045
	001 040 100060 01 00	Dış Köşe Hareketli External Corner Live	8	0.767 kg	0.01045
	001 041 100048 00 00	T Köşe T Corner	8	0.808 kg	0.01045
	001 042 100048 00 00	90° L Köşe 90° L Corner	8	0.707 kg	0.01045
	001 043 100060 00 00	Ek Parça Connector	100	0.899 kg	0.01050
	001 044 100060 00 00	Uç Tapa Blind Cap	20	0.540 kg	0.01045
	001 050 030004 00 00	Kilitleme Aparatı Locking Apparatus	-	-	-

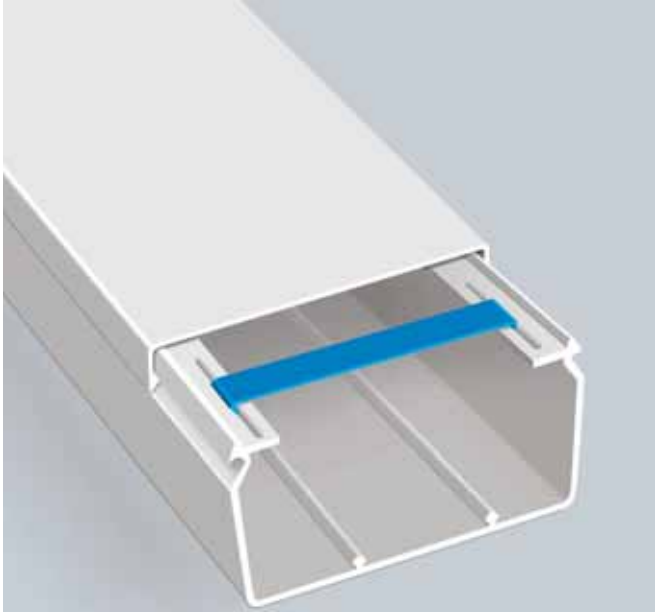

**100x60**

**Kilitleme Aparatı**  
With Locking Apparatus

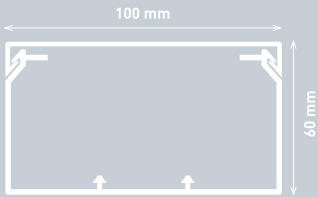

		<b>EKO</b> Seri Si Series	<b>MEKS</b> Seri Si Series	<b>CANALEX</b> Seri Si Series
Ürün Kodu	Product Code	001 014 100060 20 00	001 002 100060 20 00	001 156 100060 20 00
Ambalaj Şekli	Packing Type	Kutu - Box	Kutu - Box	Kutu - Box
Adet / m	Quantity / m	20 m	20 m	20 m
Ağırlık	Weight	22.757 kg	22.757 kg	18.557 kg
m <sup>3</sup> /	Volume	0,13590	0,13590	0,13590

**AKSESUARLAR - ACCESSORIES**

	Kod Code	Ürün Product	Adet Quantity	Ağırlık Weight	m <sup>3</sup> Volume
	001 013 100060 00 00	Ara Bölme Partition	130 m	19,36 kg	0,07956
	001 039 100060 00 00	İç Köşe Internal Corner	8	0,796 kg	0,01045
	001 039 100060 01 00	İç Köşe Hareketli Internal Corner Live	8	0,770 kg	0,00939
	001 040 100060 00 00	Dış Köşe External Corner	8	0,840 kg	0,01045
	001 040 100060 01 00	Dış Köşe Hareketli External Corner Live	10	0,958 kg	0,01045
	001 041 100060 00 00	T Köşe T Corner	8	0,890 kg	0,01045
	001 042 100060 00 00	90° L Köşe 90° L Corner	8	0,856 kg	0,01045
	001 043 100060 00 00	Ek Parça Connector	100	0,899 kg	0,01045
	001 044 100060 00 00	Uç Tapa Blind Cap	20	0,228 kg	0,00272
	001 050 030004 00 00	Kilitleme Aparatı Locking Apparatus	-	-	-



**100x100**

**Aksesuarsız**  
Without Accessories

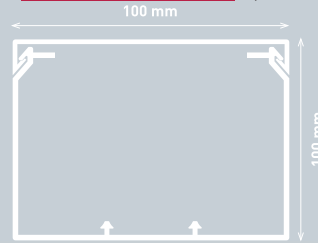

**EKO** Serisi Series

Ürün Kodu	Product Code	001 014 100100 20 00
Ambalaj Şekli	Packing Type	Kutu - Box
Adet / m	Quantity / m	320 m
Ağırlık	Weight	29.157 kg
m <sup>3</sup> /	Volume	0,13590





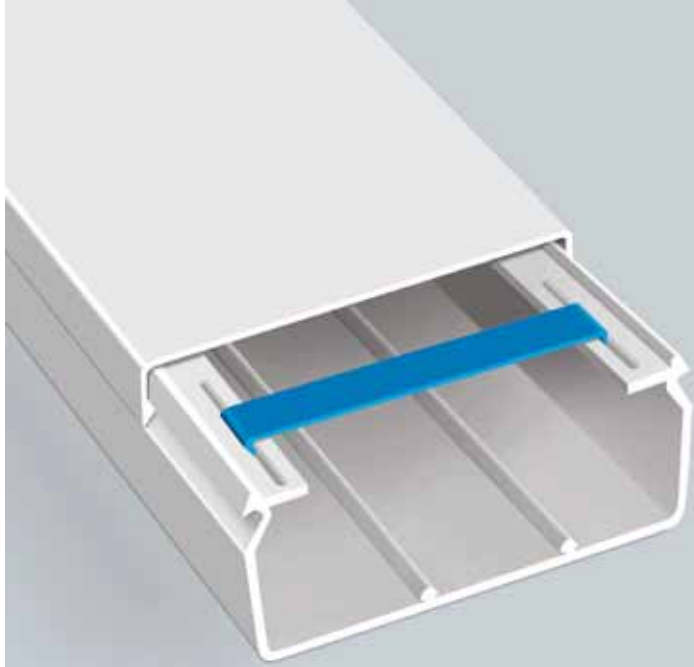

**120x60**

**Kilitleme Aparatı**  
With Locking Apparatus

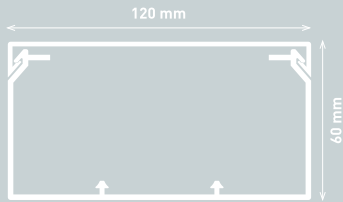

		<b>EKO</b> Serisi Series	<b>MEKS</b> Serisi Series
Ürün Kodu	Product Code	<b>001 014</b> <b>120060 20 00</b>	<b>001 002</b> <b>120060 20 00</b>
Ambalaj Şekli	Packing Type	Kutu - Box	Kutu - Box
Adet / m	Quantity / m	16 m	16 m
Ağırlık	Weight	23.677 kg	23.677 kg
m <sup>3</sup> /	Volume	0.13590	0.13590

#### AKSESUARLAR - ACCESSORIES

Kod Code	Ürün Product	Adet Quantity	Ağırlık Weight	m <sup>3</sup> Volume
 <b>001 013</b> <b>120060 20 00</b>	Ara Bölme Partition	130 m	20.010 kg	0.07956
 <b>001 039</b> <b>120060 00 00</b>	İç Köşe Internal Corner	8	0.749 kg	0.01045
 <b>001 040</b> <b>120060 00 00</b>	Dış Köşe External Corner	8	0.803 kg	0.01045
 <b>001 041</b> <b>120060 00 00</b>	T Köşe T Corner	8	0.867 kg	0.01045
 <b>001 042</b> <b>120060 00 00</b>	90° L Köşe 90° L Corner	8	0.940 kg	0.01045
 <b>001 043</b> <b>120060 00 00</b>	Ek Parça Connector	50	1.350 kg	0.01045
 <b>001 044</b> <b>120060 00 00</b>	Uç Tapa Blind Cap	20	0.279 kg	0.00282
 <b>001 050</b> <b>120060 00 00</b>	Kilitleme Aparatı Locking Apparatus	-	-	-



## MEKS 100'LÜK SERİ PRİZ MONTAJ SETLERİ

### Meks 100 Series Plug Socket Assembly Sets

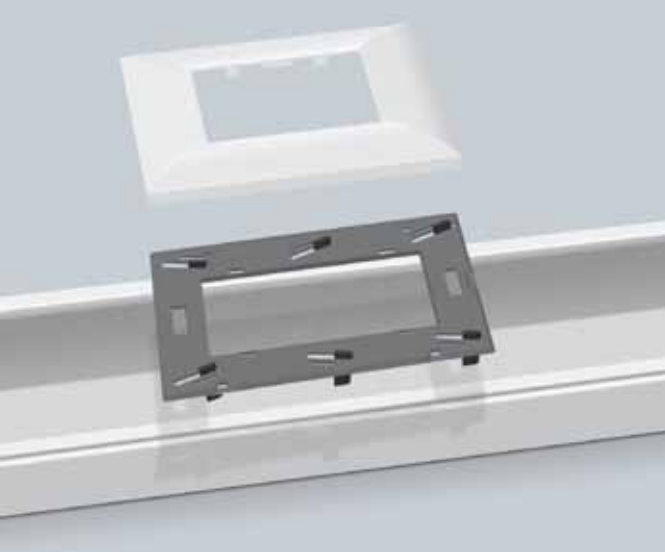

**45x45**  
**Tekli Çerçeve**  
**Single Frame**



Ürün Kodu	Product Code	001 047 040001 00 00
Ambalaj Şekli	Packing Type	Kutu - Box
Adet / m	Quantity / m	20 ad.
Ağırlık	Weight	1.216 kg
m <sup>3</sup> /	Volume	0.00262

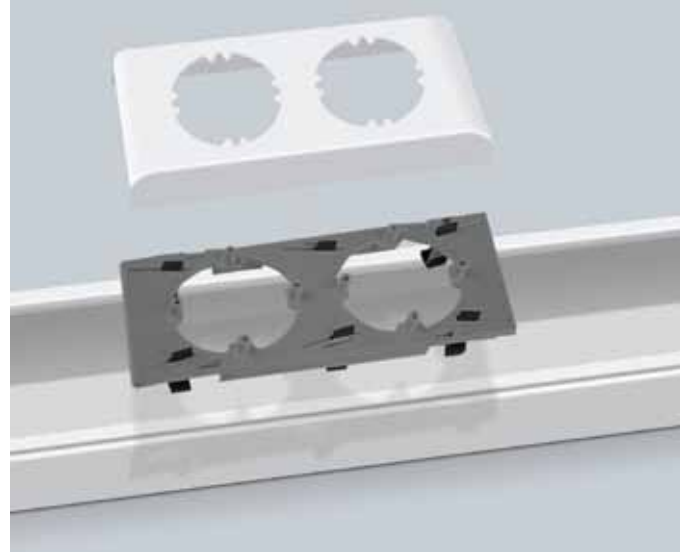

**55x55**  
**Tekli Çerçeve**  
**Single Frame**



Ürün Kodu	Product Code	001 047 020001 00 00
Ambalaj Şekli	Packing Type	Kutu - Box
Adet / m	Quantity / m	20 ad.
Ağırlık	Weight	1.216 kg
m <sup>3</sup> /	Volume	0.00262

**45x45**  
**İkili Çerçeve**  
**Double Frame**



Ürün Kodu	Product Code	001 047 040002 00 00
Ambalaj Şekli	Packing Type	Kutu - Box
Adet / m	Quantity / m	14 ad.
Ağırlık	Weight	1.143 kg
m <sup>3</sup> /	Volume	0.00536

**55x55**  
**İkili Çerçeve**  
**Double Frame**



Ürün Kodu	Product Code	001 047 020002 00 00
Ambalaj Şekli	Packing Type	Kutu - Box
Adet / m	Quantity / m	14 ad.
Ağırlık	Weight	1.143 kg
m <sup>3</sup> /	Volume	0.00536

**45x45**  
**Üçlü Çerçeve**  
**Triple Frame**



Ürün Kodu	Product Code	001 047 040003 00 00
Ambalaj Şekli	Packing Type	Kutu - Box
Adet / m	Quantity / m	14 ad.
Ağırlık	Weight	1.417 kg
m <sup>3</sup> /	Volume	0.00793

**55x55**  
**Üçlü Çerçeve**  
**Triple Frame**



Ürün Kodu	Product Code	001 047 020003 00 00
Ambalaj Şekli	Packing Type	Kutu - Box
Adet / m	Quantity / m	14 ad.
Ağırlık	Weight	1.417 kg
m <sup>3</sup> /	Volume	0.00793

**45x45**  
**Dörtlü Çerçeve**  
**Quartet Frame**



Ürün Kodu	Product Code	001 047 980002 00 00
Ambalaj Şekli	Packing Type	Kutu - Box
Adet / m	Quantity / m	10 ad.
Ağırlık	Weight	1.21 kg
m <sup>3</sup> /	Volume	0.01104



**45x22.5 Data**  
**Priz Kapağı**

**45x22.5 Data**  
**Socket Frame**

**888 049 050012**



**Data Konnektörü**  
**1x8 CAT6**

**Data Connector**  
**1x8 CAT 6**

**888 049 050032**

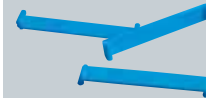

**Kanal Kilitleme**  
**Aparatı**  
**Trunking Locking**  
**Apparatus**

**001 050 030004 00 00**

Kanalda zamanla oluşabilecek esnemelerin önüne geçer.

Prevents back last that could occur in the trunking.

## İNGİLİZ NORMU PRİZ MONTAJ SETLERİ

### BRITISH NORM PLUG SOCKET ASEMBLY SETS



#### İngiliz Normu Tekli Priz Tabanı

#### British Norm Single Socket Base

Ürün Kodu	Product Code	001 047 980002 0000
Ambalaj Şekli	Packing Type	Kutu - Box
Adet / m	Quantity / m	200
Ağırlık	Weight	3.85 kg
m <sup>3</sup> /	Volume	0.04



#### İngiliz Normu İkili Priz Tabanı

#### British Norm Double Socket Base

Ürün Kodu	Product Code	001 047 980002 0000
Ambalaj Şekli	Packing Type	Kutu - Box
Adet / m	Quantity / m	100
Ağırlık	Weight	2.475 kg
m <sup>3</sup> /	Volume	0.037



#### İngiliz Normu İkili Yüksek Tip Priz Tabanı

#### British Norm Double High Type Socket Base

Ürün Kodu	Product Code	001 047 990002 00 00
Ambalaj Şekli	Packing Type	Kutu - Box
Adet / m	Quantity / m	94
Ağırlık	Weight	5.076 kg
m <sup>3</sup> /	Volume	0.0017



#### Sivaaltı Anahtar Kasası (Kare Buat)

#### Flush Mounted Switch Casing (Square Junction Box)

Ürün Kodu	Product Code	001 166 000001 00 00
Ambalaj Şekli	Packing Type	Kutu - Box
Adet / m	Quantity / m	28
Ağırlık	Weight	1.18 kg
m <sup>3</sup> /	Volume	0.011

# MEKSPLUS SERİSİ İÇTEN KAPAKLI KANALLAR

## MEKSPLUS SERIES WITH INTRINSIC COVER TRUNKING



**İçten Kapaklı**  
Intrinsic Cover

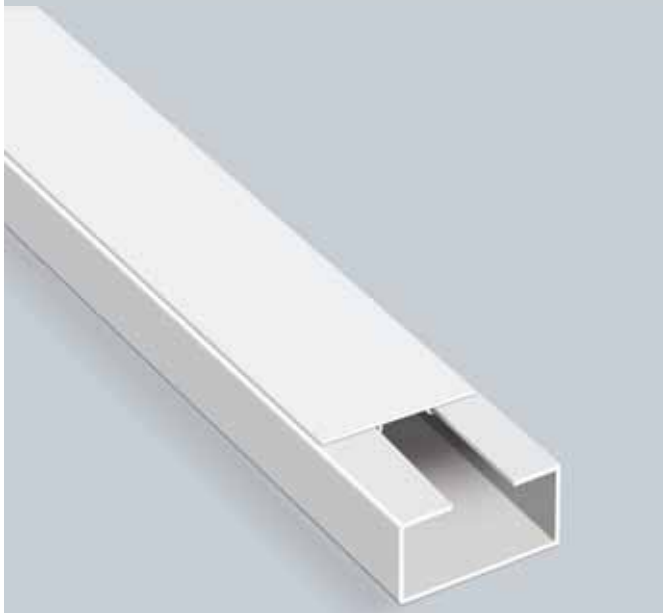
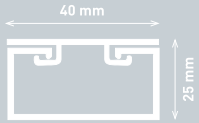

**40x25****Aksesuarsız**  
Without Accessories**MEKSPLUS** Serisi - Series

Ürün Kodu	Product Code	<b>001 003 040025 20 00</b>
Ambalaj Şekli	Packing Type	Kutu - Box
Adet / m	Quantity / m	80 m
Ağırlık	Weight	26.843 kg
m <sup>3</sup> /	Volume	0.09592

**Koruma Bantlı**  
Protecting Foil**100x37****EKO** Serisi - Series**MEKS** Serisi - Series**MEKSPLUS** Serisi - Series

Ürün Kodu	Product Code	<b>001 014 100037 20 00</b>	<b>001 002 100037 20 00</b>	<b>001 003 100037 20 00</b>
Ambalaj Şekli	Packing Type	Kutu - Box	Kutu - Box	Kutu - Box
Adet / m	Quantity / m	30 m	30 m	30 m
Ağırlık	Weight	29.067 kg	29.067 kg	29.067 kg
m <sup>3</sup> /	Volume	0.12546	0.12546	0.12546

**AKSESUARLAR - ACCESSORIES**

	Kod Code	Ürün Product	Adet Quantity	Ağırlık Weight	m <sup>3</sup> Volume
	<b>001 013 100037 00 00</b>	Ara Bölme Partition	200 m	19.65 kg	0.054
	<b>001 039 100037 00 00</b>	İç Köşe Internal Corner	12	0.927 kg	0.00984
	<b>001 039 100050 01 00</b>	İç Köşe Hareketli Internal Corner Live	12	0.696 kg	0.00984
	<b>001 040 100037 00 00</b>	Dış Köşe External Corner	8	0.570 kg	0.00984
	<b>001 040 100050 01 00</b>	Dış Köşe Hareketli External Corner Live	10	0.895 kg	0.01011
	<b>001 041 100037 00 00</b>	T Köşe T Corner	12	0.990 kg	0.01011
	<b>001 042 100037 00 00</b>	90° L Köşe 90° L Corner	12	0.856 kg	0.00984
	<b>001 043 100050 00 00</b>	Ek Parça Connector	100	1.5 kg	0.01050
	<b>001 044 100037 00 00</b>	Uç Tapa Blind Cap	50	0.702 kg	0.00272





**Koruma Bantlı**  
Protecting Foil

**100x41**



Ürün Kodu	Product Code	MEKS	MEKSPLUS
		Serisi - Series	Serisi - Series
001 013	100040 20 00	001 002	001 003
Ambalaj Şekli	Packing Type	Kutu - Box	Kutu - Box
Adet / m	Quantity / m	324 m	324 m
Ağırlık	Weight	21.918 kg	21.918 kg
m <sup>3</sup> /	Volume	0.12221	0.12221

#### AKSESUARLAR - ACCESSORIES

Kod Code	Ürün Product	Adet Quantity	Ağırlık Weight	m <sup>3</sup> Volume
001 013 100040 20 00	Ara Bölme Partition	200 m	21.05 kg	0.054
001 039 100050 00 00	İç Köşe Internal Corner	8	0.443 kg	0.00984
001 039 100050 01 00	İç Köşe Hareketli Internal Corner Live	12	0.847 kg	0.00984
001 040 100050 00 00	Dış Köşe External Corner	8	0.722 kg	0.00984
001 040 100050 01 00	Dış Köşe Hareketli External Corner Live	10	0.895 kg	0.01011
001 041 100050 00 00	T Köşe T Corner	8	0.647 kg	0.00984
001 042 100050 00 00	90° L Köşe 90° L Corner	8	0.611 kg	0.00984
001 043 100050 00 00	Ek Parça Connector	100	1.394 kg	0.01011
001 044 100050 00 00	Uç Tapa Blind Cap	40	0.711 kg	0.00984



**Koruma Bantlı**  
Protecting Foil

**100x50**



**Kanal İçi Küp Buat**  
Duct Junction Cube



Ürün Kodu	Product Code	CANALEX	EKO	MEKS	MEKSPLUS
		Serisi - Series	Serisi - Series	Serisi - Series	Serisi - Series
001 156	100050 20 00	001 014	100050 20 00	001 002	001 003
Ambalaj Şekli	Packing Type	Kutu - Box	Kutu - Box	Kutu - Box	Kutu - Box
Adet / m	Quantity / m	20 m	20 m	20 m	20 m
Ağırlık	Weight	17.79 kg	19.37 kg	21.46 kg	22.31 kg
m <sup>3</sup> /	Volume	0.127	0.127	0.127	0.127

#### AKSESUARLAR - ACCESSORIES

Kod Code	Ürün Product	Adet Quantity	Ağırlık Weight	m <sup>3</sup> Volume
001 013 100048 20 00	Ara Bölme Partition	150 m	19.61 kg	0.075
001 039 100050 00 00	İç Köşe Internal Corner	8	0.443 kg	0.00984
001 039 100050 01 00	İç Köşe Hareketli Internal Corner Live	12	0.847 kg	0.00984
001 040 100050 00 00	Dış Köşe External Corner	8	0.722 kg	0.00984
001 040 100050 01 00	Dış Köşe Hareketli External Corner Live	10	0.895 kg	0.01011
001 041 100050 00 00	T Köşe T Corner	8	0.647 kg	0.00984
001 042 100050 00 00	90° L Köşe 90° L Corner	8	0.611 kg	0.00984
001 043 100050 00 00	Ek Parça Connector	100	1.394 kg	0.01011
001 044 100050 00 00	Uç Tapa Blind Cap	40	0.711 kg	0.00984
001 043 100050 01 00	Ek parça (3'lü Set) Connector (3 set)	100	1.430 kg	0.00987
001 046 195100 00 00	Kanal İçi Küp Buat Duct Junction Cube	25	1.180 kg	0.0086



**Koruma Bantlı**  
Protecting Foil

**100x50**

**Kaidesiz**  
Compatible With Mounting  
Without Base

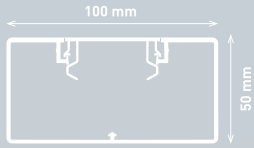

**MEKPLUS** Serisi Series

Ürün Kodu	Product Code	<b>001 006 100050 20 00</b>
Ambalaj Şekli	Packing Type	Kutu - Box
Adet / m	Quantity / m	20 m
Ağırlık	Weight	22.17 kg
m <sup>3</sup> /	Volume	0.120

#### AKSESUARLAR - ACCESSORIES

Kod Code	Ürün Product	Adet Quantity	Ağırlık Weight	m <sup>3</sup> Volume
 <b>001 013 100048 20 00</b>	Ara Bölme Partition	150 m	19.61 kg	0.075
 <b>001 039 100051 00 00</b>	İç Köşe Internal Corner	8	0.443 kg	0.00984
 <b>001 040 100051 00 00</b>	Dış Köşe External Corner	8	0.722 kg	0.00984
 <b>001 041 100051 00 00</b>	T Köşe T Corner	8	0.647 kg	0.01011
 <b>001 042 100051 00 00</b>	90° L Köşe 90° L Corner	8	0.611 kg	0.00984
 <b>001 043 100051 00 00</b>	Ek Parça Connector	100	1.394 kg	0.01011
 <b>001 044 100051 00 00</b>	Uç Tapa Blind Cap	40	0.711 kg	0.00984
 <b>001 888 100050 00 00</b>	Kilitleme Aparatı Locking Apparatus	50	-	-



**120x70**

**Aksesuarsız**  
Without Accessories



**MEKPLUS** Serisi Series

Ürün Kodu	Product Code	<b>001 003 120070 20 00</b>
Ambalaj Şekli	Packing Type	Kutu - Box
Adet / m	Quantity / m	16 m
Ağırlık	Weight	25.673 kg
m <sup>3</sup> /	Volume	0.18189

#### AKSESUARLAR - ACCESSORIES

Kod Code	Ürün Product	Adet Quantity	Ağırlık Weight	m <sup>3</sup> Volume
 <b>001 013 120070 20 00</b>	Ara Bölme Partition	60 m	10.16 kg	0.080

**NEW YENİ**

**100x50**

**Kaidesiz**  
Compatible With Mounting  
Without Base





**Koruma Bantlı**  
Protecting Foil



**170x50**



**MEKSPLUS** Serisi Series

Ürün Kodu	Product Code	<b>001 003 170050 20 00</b>
Ambalaj Şekli	Packing Type	Kutu - Box
Adet / m	Quantity / m	12 m
Ağırlık	Weight	19.23 kg
m <sup>3</sup> /	Volume	0.174

#### AKSESUARLAR - ACCESSORIES

Kod Code	Ürün Product	Adet Quantity	Ağırlık Weight	m <sup>3</sup> Volume
<b>001 013 170070 20 00</b>	Ara Bölme Partition	60 m	10.16 kg	0.080



**170x70**

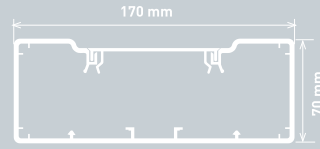

**Aksesuarsız**  
Without Accessories

**MEKSPLUS** Serisi Series

Ürün Kodu	Product Code	<b>001 003 170070 20 00</b>
Ambalaj Şekli	Packing Type	Kutu - Box
Adet / m	Quantity / m	12 m
Ağırlık	Weight	29.23 kg
m <sup>3</sup> /	Volume	0.174

#### AKSESUARLAR - ACCESSORIES

Kod Code	Ürün Product	Adet Quantity	Ağırlık Weight	m <sup>3</sup> Volume
<b>001 013 170070 20 00</b>	Ara Bölme Partition	60 m	10.16 kg	0.080

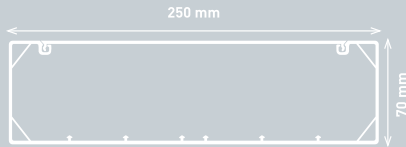
**250x70****Aksesuarsız**  
Without Accessories**MEKPLUS** Serisi Series

Ürün Kodu	Product Code	<b>001 003 250070 20 00</b>
Ambalaj Şekli	Packing Type	Kutu - Box
Adet / m	Quantity / m	8 m
Ağırlık	Weight	24.073 kg
m <sup>3</sup> /	Volume	0.17357

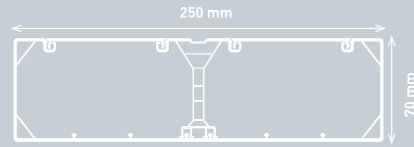
**Priz Montaj Setsiz**  
Without Plug Socket Assembly Set**250x70****Bölmeli - Partitioned**  
**Aksesuarsız - Without Accessories****MEKPLUS** Serisi Series

Ürün Kodu	Product Code	<b>001 003 250970 20 00</b>
Ambalaj Şekli	Packing Type	Kutu - Box
Adet / m	Quantity / m	8 m
Ağırlık	Weight	28.713 kg
m <sup>3</sup> /	Volume	0.17357

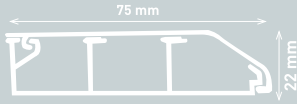

# 75x22

**MEKS** Serisi Series

Ürün Kodu	Product Code	<b>001 002 075022 20 00</b>
Ambalaj Şekli	Packing Type	Kutu - Box
Adet / m	Quantity / m	50 m
Ağırlık	Weight	33.743 kg
m <sup>3</sup> /	Volume	0.09685

### AKSESUARLAR - ACCESSORIES

Kod Code	Ürün Product	Adet Quantity	Ağırlık Weight	m <sup>3</sup> Volume
<b>001 039 075022 00 00</b>	İç Köşe Internal Corner	1	0.015 kg.	0.00009
<b>001 040 075022 00 00</b>	Dış Köşe External Corner	1	0.016 kg.	0.00008
<b>001 043 075022 00 00</b>	Ek Parça Connector	1	0.004 kg.	0.00003
<b>001 044 075022 01 00</b>	Sağ Uç Tapa Blind Cap Right	1	0.004 kg.	0.00003
<b>001 044 075022 02 00</b>	Sol Uç Tapa Blind Cap Left	1	0.004 kg.	0.00003



# 74x20

**Tam Kapaklı Bölmeli**  
Full Cover And Partitioned

**EKO** Serisi Series

**MEKS** Serisi Series

Ürün Kodu	Product Code	<b>001 014 974020 20 00</b>	<b>001 002 974020 20 00</b>
Ambalaj Şekli	Packing Type	Kutu - Box	Kutu - Box
Adet / m	Quantity / m	50 m	50 m
Ağırlık	Weight	27.493 kg	27.493 kg
m <sup>3</sup> /	Volume	0.0938	0.0938

### AKSESUARLAR - ACCESSORIES

Kod Code	Ürün Product	Adet Quantity	Ağırlık Weight	m <sup>3</sup> Volume
<b>001 039 074020 00 00</b>	İç Köşe Internal Corner	20	0.250 kg	0.00262
<b>001 040 074020 00 00</b>	Dış Köşe External Corner	20	0.299 kg	0.00730
<b>001 041 074020 00 00</b>	T Köşe T Corner	30	1.182 kg	0.00730
<b>001 042 074020 01 00</b>	90° L Köşe 90° L Corner	40	1.260 kg	0.00730
<b>001 043 074020 00 00</b>	Ek Parça Connector	50	0.350 kg	0.00730
<b>001 044 074020 00 00</b>	Uç Tapa Blind Cap	50	0.505 kg	0.00730
<b>001 047 0117420 00 00</b>	P. M Kasası Socket Assembly Frame	6	0.574 kg	-
<b>001 047 017421 00 00</b>	P. M Kasası 1'li Socket Assembly Frame Single	12	1.161 kg	0.00731
<b>001 043 017422 00 00</b>	P. M Kasası 2'li Socket Assembly Frame Double	-	-	-
<b>001 043 017423 00 00</b>	P. M Kasası 3'lü Socket Assembly Frame Triple	-	-	-



## MEKSPLUS SERİ PRİZ MONTAJ SETLERİ

### Plug Socket Assembly Sets for Meksplus Series

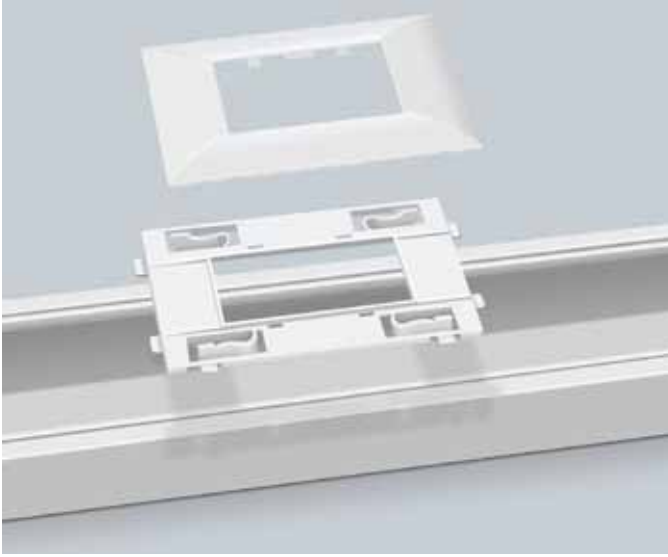

#### 45x45 Tekli Çerçeve Single Frame



Ürün Kodu	Product Code	001 047 070001 00 00
Ambalaj Şekli	Packing Type	Kutu - Box
Adet / m	Quantity / m	20 ad.
Ağırlık m <sup>3</sup> /	Weight Volume	0.99 kg 0.00566

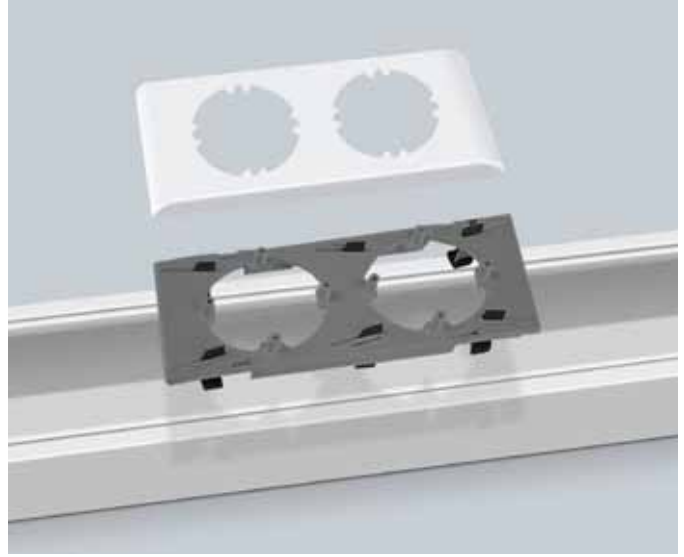

#### 55x55 Tekli Çerçeve Single Frame



Ürün Kodu	Product Code	001 047 080001 00 00
Ambalaj Şekli	Packing Type	Kutu - Box
Adet / m	Quantity / m	20 ad.
Ağırlık m <sup>3</sup> /	Weight Volume	1.145 kg 0.0063

#### 45x45 İkili Çerçeve Double Frame



Ürün Kodu	Product Code	001 047 070002 00 00
Ambalaj Şekli	Packing Type	Kutu - Box
Adet / m	Quantity / m	14 ad.
Ağırlık m <sup>3</sup> /	Weight Volume	0.923 kg 0.00566

#### 55x55 İkili Çerçeve Double Frame



Ürün Kodu	Product Code	001 047 080002 00 00
Ambalaj Şekli	Packing Type	Kutu - Box
Adet / m	Quantity / m	14 ad.
Ağırlık m <sup>3</sup> /	Weight Volume	1.12 kg 0.0063

#### 45x45 Üçlü Çerçeve Triple Frame



Ürün Kodu	Product Code	001 047 070003 00 00
Ambalaj Şekli	Packing Type	Kutu - Box
Adet / m	Quantity / m	12 ad.
Ağırlık m <sup>3</sup> /	Weight Volume	0.947 kg 0.0068

#### 55x55 Üçlü Çerçeve Triple Frame



Ürün Kodu	Product Code	001 047 080003 00 00
Ambalaj Şekli	Packing Type	Kutu - Box
Adet / m	Quantity / m	10 ad.
Ağırlık m <sup>3</sup> /	Weight Volume	1.113 kg 0.0063

#### 45x45 Dörtlü Çerçeve Quartet Frame



Ürün Kodu	Product Code	001 047 070004 00 00
Ambalaj Şekli	Packing Type	Kutu - Box
Adet / m	Quantity / m	10 ad.
Ağırlık m <sup>3</sup> /	Weight Volume	1.18 kg 0.0062

001 052 300001 00 00  
45x45 Topraklı  
Priz Çekirdekleri 45°  
45x45 Earthed Socket Cores 45°



001 052 300002 00 00  
45x45 UPS  
Priz Çekirdekleri 45°  
45x45 UPS Socket Cores 45°



001 052 200005 00 00  
45x45 UPS ve Topraklı  
Priz Birleştirme Aparatı  
45x45 UPS and Grounded  
Socket Joining Apparatus



888 049 050013  
45x45 Data Priz Kapağı  
45x45 Data Socket Cover



001 050 030003 00 00  
100x37/50  
Kanal Kilitleme Aparatı  
Trunking Locking Apparatus



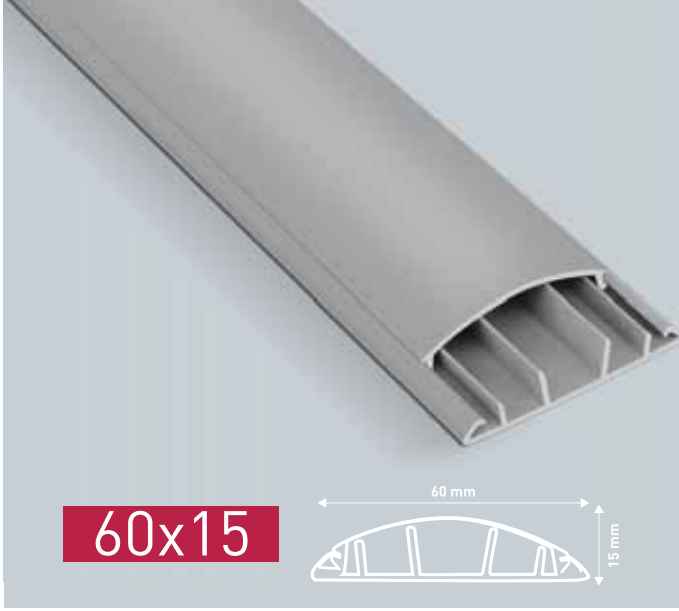

Ürün Kodu	Product Code	001 002 060015 20 17
Ambalaj Şekli	Packing Type	Kutu - Box
Adet / m	Quantity / m	500 m
Ağırlık	Weight	18,4 kg
m <sup>3</sup> /	Volume	0,0435





**AKSESUARLAR - ACCESSORIES**

Kod Code	Ürün Product	Adet Quantity	Ağırlık Weight	m <sup>3</sup> Volume
 <b>001 041</b> <b>060015 00 17</b>	T Köşe T Corner	10	0,414 kg	0,00234
 <b>001 042</b> <b>060015 00 17</b>	L Köşe L Corner	24	0,429 kg	0,00272
 <b>001 043</b> <b>060015 00 17</b>	Ek Parça Connector	50	0,187 kg	0,00130
 <b>001 044</b> <b>060015 00 17</b>	Uç Tapa Blind Cap	50	0,197 kg	0,00130



Ürün Kodu	Product Code	001 002 075018 20 17
Ambalaj Şekli	Packing Type	Kutu - Box
Adet / m	Quantity / m	60 m
Ağırlık	Weight	37,76 kg
m <sup>3</sup> /	Volume	0,0828





**AKSESUARLAR - ACCESSORIES**

Kod Code	Ürün Product	Adet Quantity	Ağırlık Weight	m <sup>3</sup> Volume
 <b>001 041</b> <b>075018 00 17</b>	T Köşe T Corner	8	0,454 kg	0,00279
 <b>001 042</b> <b>075018 00 17</b>	L Köşe L Corner	20	0,524 kg	0,00279
 <b>001 043</b> <b>075018 00 17</b>	Ek Parça Connector	50	0,200 kg	0,00131
 <b>001 044</b> <b>075018 00 17</b>	Uç Tapa Blind Cap	50	0,273 kg	0,00134



Ürün Kodu	Product Code	001 002 090020 20 17
Ambalaj Şekli	Packing Type	Kutu - Box
Adet / m	Quantity / m	40 m
Ağırlık	Weight	33,16 kg
m <sup>3</sup> /	Volume	0,07956

**AKSESUARLAR - ACCESSORIES**

Kod Code	Ürün Product	Adet Quantity	Ağırlık Weight	m <sup>3</sup> Volume
 <b>001 041</b> <b>090020 00 17</b>	T Köşe T Corner	10	0,851 kg	0,00842
 <b>001 042</b> <b>090020 00 17</b>	L Köşe L Corner	20	0,778 kg	0,00653
 <b>001 043</b> <b>090020 00 17</b>	Ek Parça Connector	50	0,215 kg	0,00134
 <b>001 044</b> <b>090020 00 17</b>	Uç Tapa Blind Cap	50	0,275 kg	0,00134



## H Profil 8

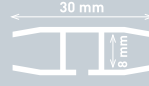

Ürün Kodu	Product Code	001 015 008000 20 00
Ambalaj Şekli	Packing Type	Kutu - Box
Adet / m	Quantity / m	100 m
Ağırlık	Weight	16.5 kg
m <sup>3</sup> /	Volume	0.03121

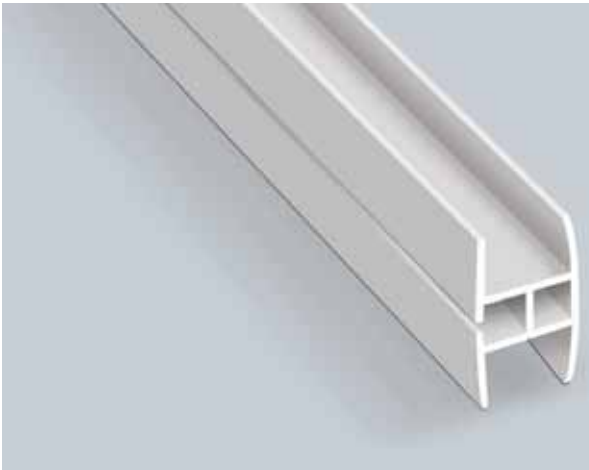

## H Profil 10

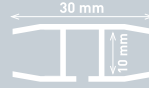

Ürün Kodu	Product Code	001 015 010000 20 00
Ambalaj Şekli	Packing Type	Kutu - Box
Adet / m	Quantity / m	100 m
Ağırlık	Weight	18 kg
m <sup>3</sup> /	Volume	0.03745

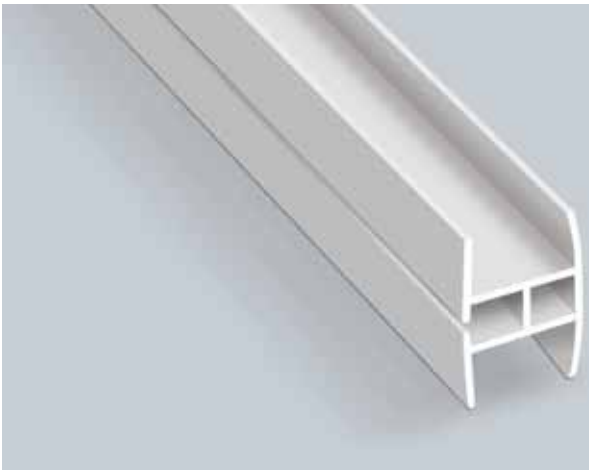

## H Profil 12

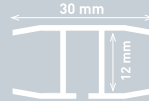

Ürün Kodu	Product Code	001 015 012000 20 00
Ambalaj Şekli	Packing Type	Kutu - Box
Adet / m	Quantity / m	100 m
Ağırlık	Weight	19.5 kg
m <sup>3</sup> /	Volume	0.04369



## 9.5x7



**Seffaf Mini Kanal**  
(Kapaksız - Yapışkanlı)  
Transparent Mini Trunking  
(Without Cover - With Adhesive)

Ürün Kodu	Product Code	001 004 010007 20 44
Ambalaj Şekli	Packing Type	Kutu - Box
Adet / m	Quantity / m	500 m
Ağırlık	Weight	16.45 kg
m <sup>3</sup> /	Volume	0.0435

# KLİMA KANALI

## AIR CONDITIONING TRUNKING



**Dış Uç Tapa**  
External Blind Cap

**Ek Parça**  
Connector

**İç Köşe**  
Internal Corner



**90° L Köşe**  
90° L Corner

**Kablo Tutucu**  
Cable Holder

**Dış Köşe**  
External Corner

**Duvar Geçisi**  
Wall Penetration



**MEKS** Serisi Series

Ürün Kodu	Product Code	001 002 075060 20 00
Ambalaj Şekli	Packing Type	Kutu - Box
Adet / m	Quantity / m	30 m
Ağırlık	Weight	19.543 kg
m <sup>3</sup> /	Volume	0.09663

**AKSESUARLAR - ACCESSORIES**

Kod Code	Ürün Product	Adet Quantity	Ağırlık Weight	m <sup>3</sup> Volume
 <b>001 039</b> <b>075060 00 00</b>	İç Köşe Internal Corner	24	2.485 kg	0.00732
 <b>001 040</b> <b>075060 00 00</b>	Dış Köşe External Corner	24	0.897 kg	0.00984
 <b>001 042</b> <b>075060 00 00</b>	90° L Köşe 90° L Corner	18	1.040 kg	0.00984
 <b>001 043</b> <b>075060 00 00</b>	Ek Parça Connector	40	0.440 kg	0.00280
 <b>001 044</b> <b>075060 01 00</b>	İç Uç Tapa Internal Blind Cap	30	0.870 kg	0.01045
 <b>001 044</b> <b>075060 02 00</b>	Dış Uç Tapa External Blind Cap	18	0.684 kg	0.01045
 <b>001 050</b> <b>030001 00 00</b>	Duvar Geçişli Wall Penetration	-	-	-
 <b>001 050</b> <b>030002 00 00</b>	Kablo Tutucu Cable Holder	-	-	-

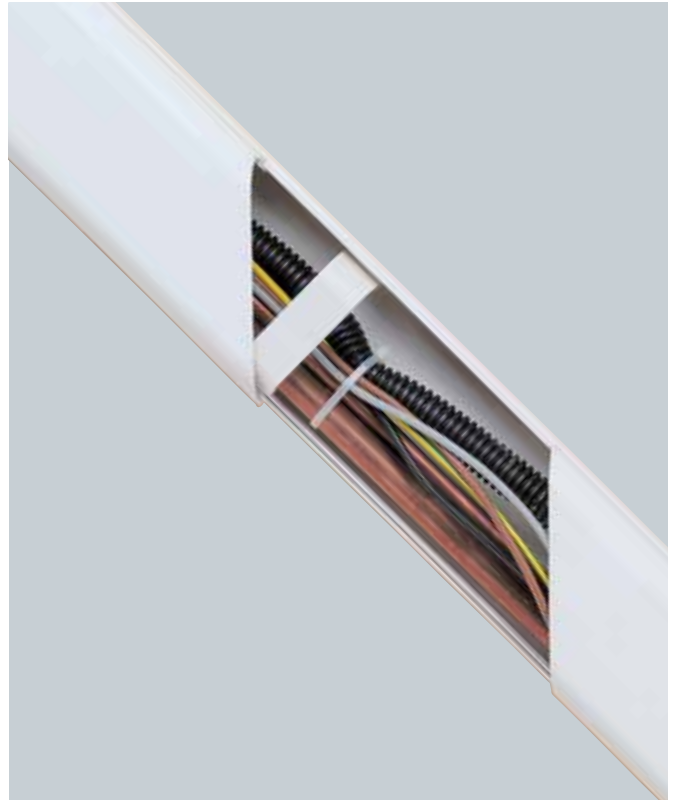
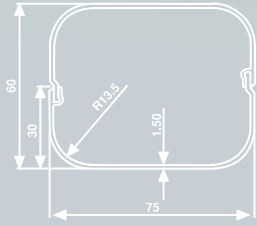
**75x60**



# SİDEM SERİSİ KABLO KANALLARI

## SIDEM SERIES CABLE TRUNKING



**SİDEM**

**Tüm ebatlardaki kablo kanallarımız ve aksesuarları bu bölümdeki renk seçenekleri ile boyanabilir özelliklerdedir.**

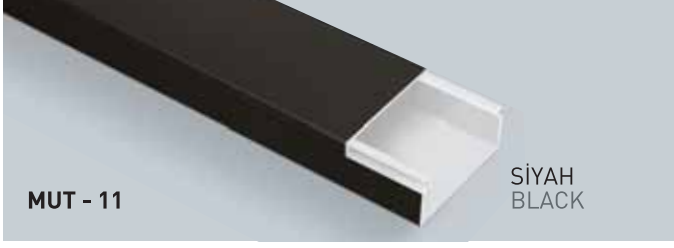
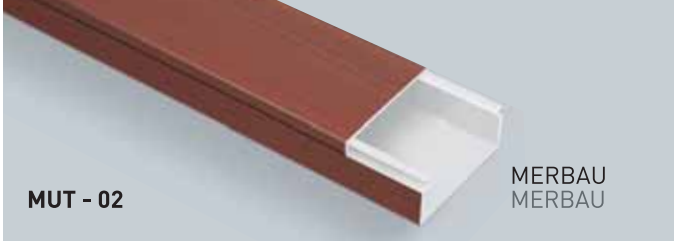

The cable trunking and accessories of all sizes can be painted with the available color options presented in this chapter.

**RENK SEÇENEKLERİ** COLOR OPTIONS**AHŞAP RENK SEÇENEKLERİ** WOOD COLOR OPTIONS**AKSESUARLAR** ACCESSORIES

# Delikli Kablo Kanallarımızın Teknik Özellikleri

## Technical Specifications Perforated Cable Trunking



Ultraviyole ışınlarına  
karşı dayanıklıdır.  
Resistance to  
UV Light



Aşit buharına  
dayanıklılıdır  
Resistance to  
acidic vapor

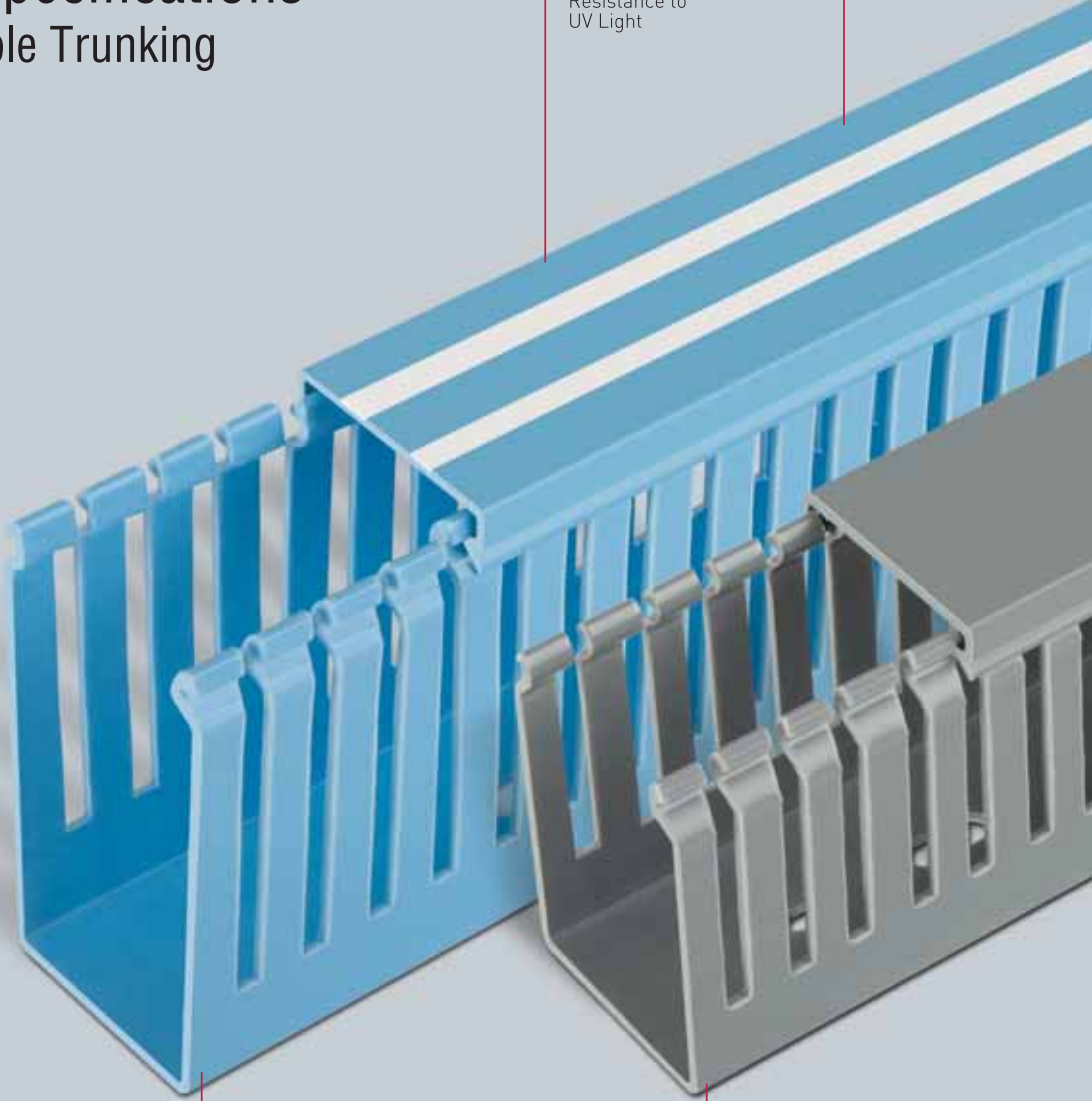

Daha pratik ve kolay montaj  
için tüm kanallarımız çift  
tarafli yapışkanlı bant ile  
kullanılabilir

Adhesive models  
are easy to install

**-25°C+60°C**

Aşırı soğuğa ve sicağa  
karşı dayanıklı

Resistant to extreme  
cold and heat

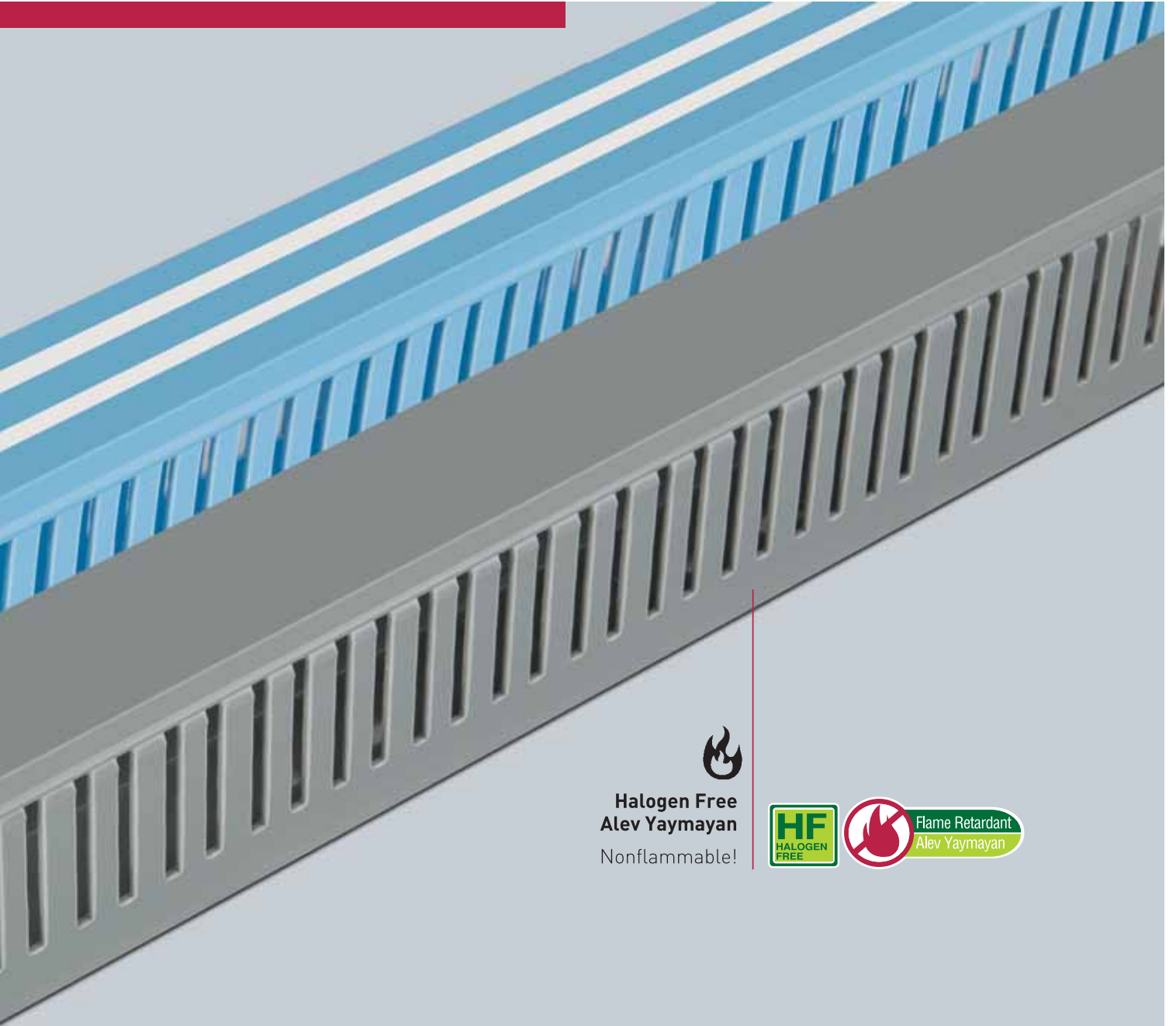

**Halogen Free**  
**Alev Yaymayan**  
Nonflammable!



**Flame Retardant**  
**Alev Yaymayan**

**Kolay yapışmayı sağlayan,  
Çift taraflı bant kullanılabilir.**

Double sided adhesive  
Tape assuring easy fixation  
Can be used

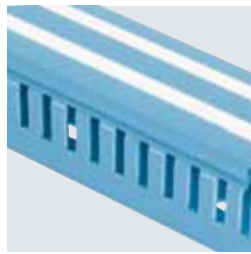
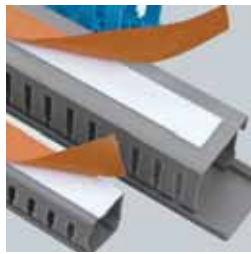

**Yazı yazmayı kolaylaştıran  
beyaz bant**

Easy-to-write  
white strips

**Kablo çıkışları için  
belirli aralıklar**

Regular intervals for  
cable outlets

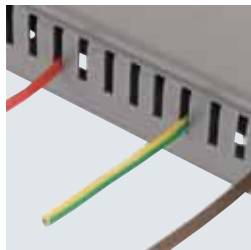

**Düzenli aralıklarla  
montaj delikleri**

Assembly holes with  
regular intervals



# HALOGEN FREE DELİKLİ KABLO KANALI

## HALOGEN FREE PERFORATED CABLE TRUNKING



Flame Retardant  
Alev Yaymayan

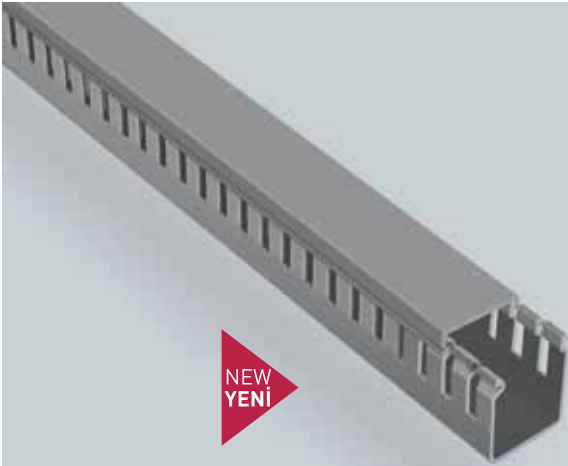

NEW  
YENI



Flame Retardant  
Alev Yaymayan

25x25

Gri  
Grey

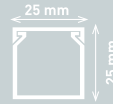

Ürün Kodu	Product Code	001 005 025025 20 17
Ambalaj Şekli	Packing Type	Kutu - Box
Adet / m	Quantity / m	128 m
Ağırlık	Weight	26.865 kg
m <sup>3</sup> /	Volume	0.0992

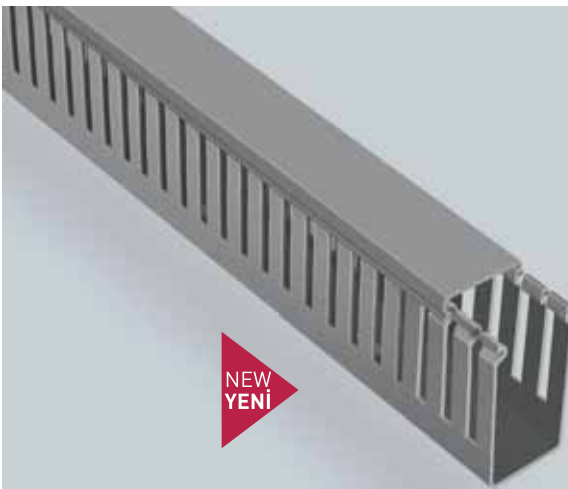

NEW  
YENI



Flame Retardant  
Alev Yaymayan

25x40

Gri  
Grey

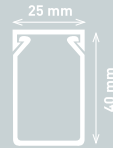

Ürün Kodu	Product Code	001 005 025040 20 17
Ambalaj Şekli	Packing Type	Kutu - Box
Adet / m	Quantity / m	80 m
Ağırlık	Weight	23,665 kg
m <sup>3</sup> /	Volume	0.0992

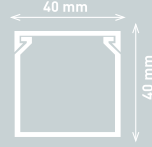

**40x40****Gri**  
Grey

Ürün Kodu	Product Code	001 005 040040 20 17
Ambalaj Şekli	Packing Type	Kutu - Box
Adet / m	Quantity / m	50 m
Ağırlık	Weight	18.765 kg
m <sup>3</sup> /	Volume	0.0992

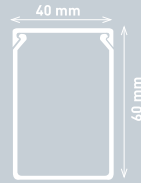
**40x60****Gri**  
Grey

Ürün Kodu	Product Code	001 005 040060 20 17
Ambalaj Şekli	Packing Type	Kutu - Box
Adet / m	Quantity / m	48 m
Ağırlık	Weight	23.11 kg
m <sup>3</sup> /	Volume	0.1439

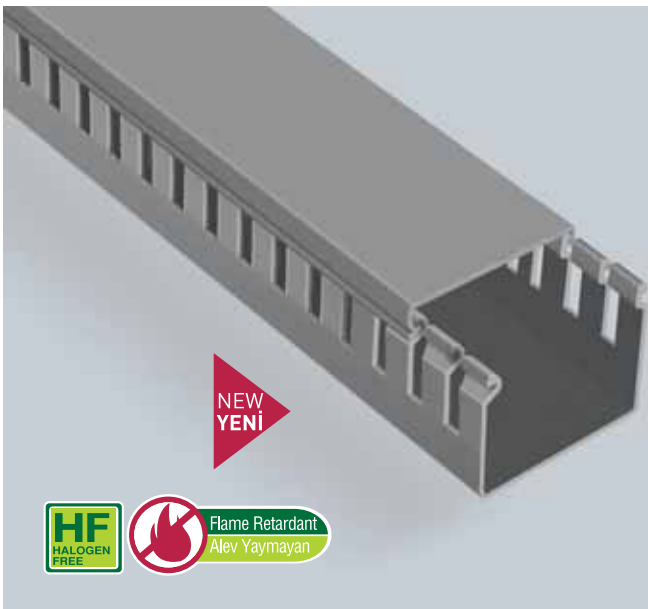
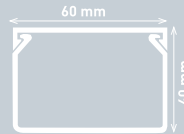
**60x40****Gri**  
Grey

Ürün Kodu	Product Code	001 005 060040 20 17
Ambalaj Şekli	Packing Type	Kutu - Box
Adet / m	Quantity / m	48 m
Ağırlık	Weight	25.51 kg
m <sup>3</sup> /	Volume	0.1439

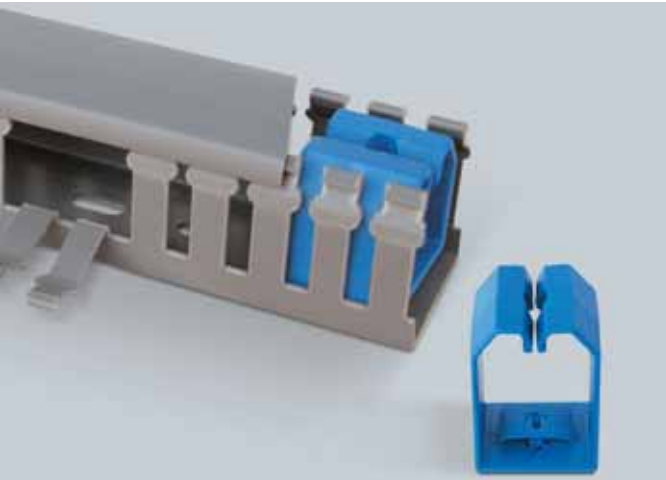
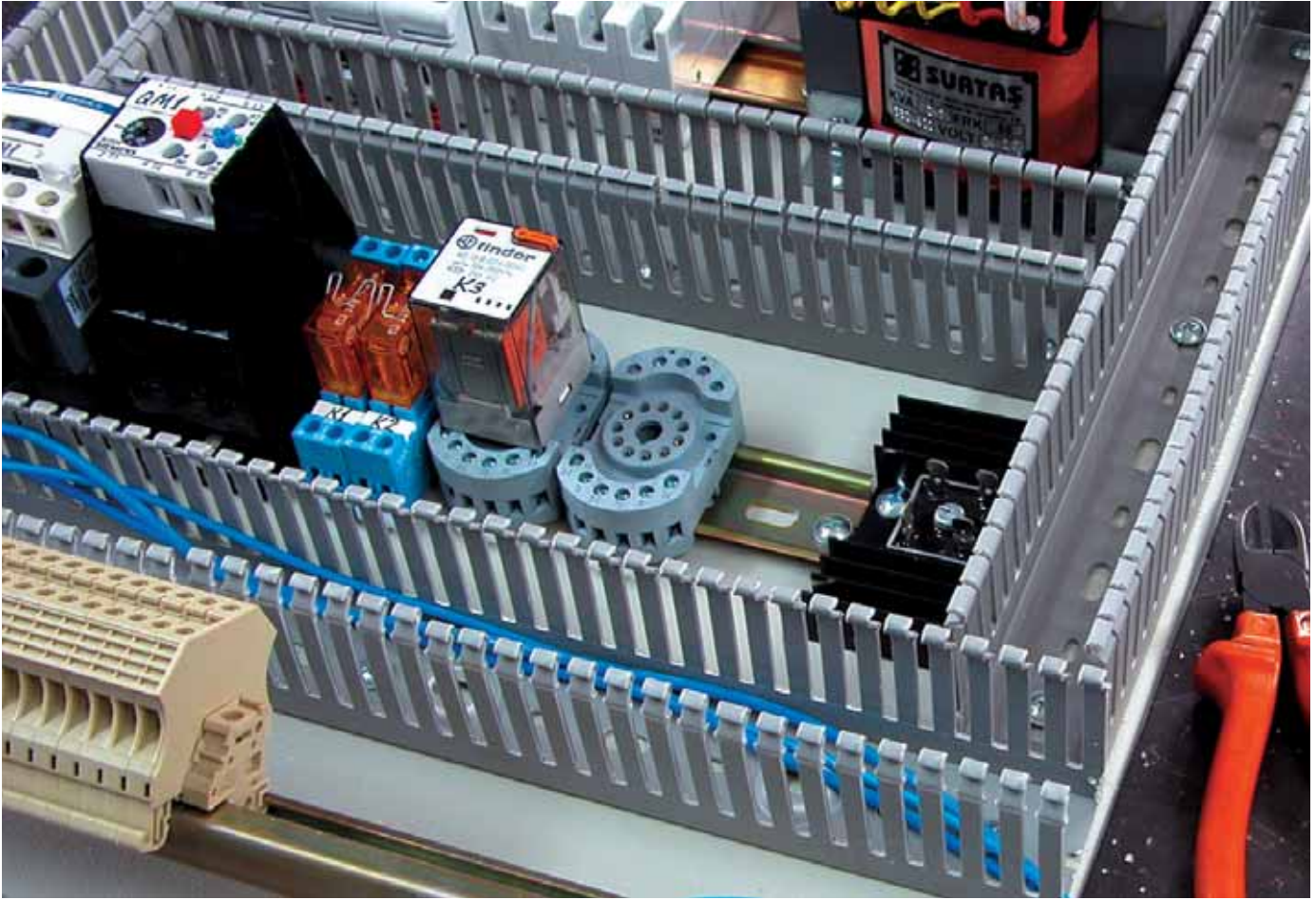

**Kablo Tutucu Aparatı**  
Cable Holder Apparatus

		25x40	40x40	60x40
Ürün Kodu	Product Code	001 050 010001 00 00	001 050 010002 00 00	001 050 010003 00 00
Ambalaj Şekli	Packing Type	Kutu - Box	Kutu - Box	Kutu - Box
Adet / m	Quantity / m	- m	- m	- m
Ağırlık	Weight	- kg	- kg	- kg
m <sup>3</sup> /	Volume	-	-	-

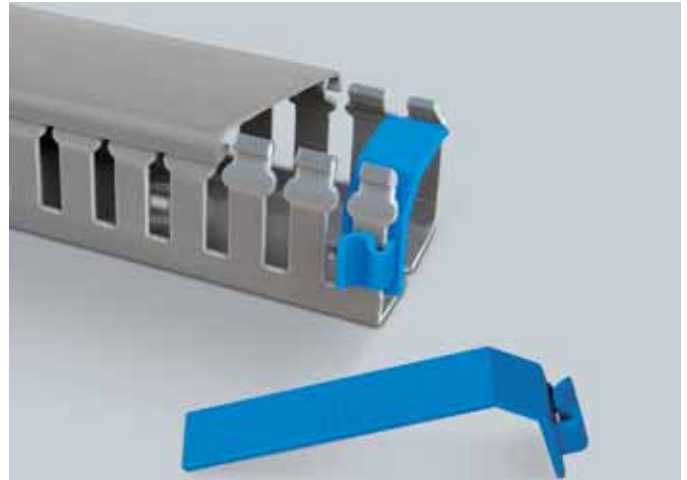

**Kablo Tutucu Yan Aparatı**  
Cable Holder Side Apparatus

		40x40/60	60x40/60	80x60	100x60
Ürün Kodu	Product Code	001 050 020001 00 00	001 050 020002 00 00	001 050 020003 00 00	001 050 020004 00 00
Ambalaj Şekli	Packing Type	Kutu - Box	Kutu - Box	Kutu - Box	Kutu - Box
Adet / m	Quantity / m	- m	- m	- m	- m
Ağırlık	Weight	- kg	- kg	- kg	- kg
m <sup>3</sup> /	Volume	-	-	-	-

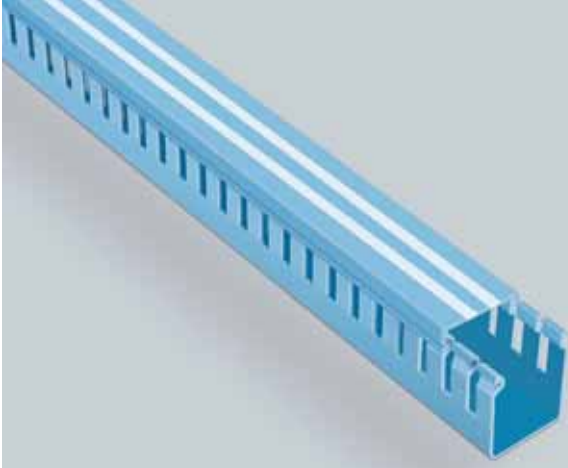
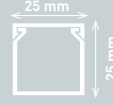
**25x25****Mavi**  
Blue

Ürün Kodu	Product Code	001 005 025025 20 13
Ambalaj Şekli	Packing Type	Kutu - Box
Adet / m	Quantity / m	128 m
Ağırlık	Weight	26.865 kg
m <sup>3</sup> /	Volume	0.0992

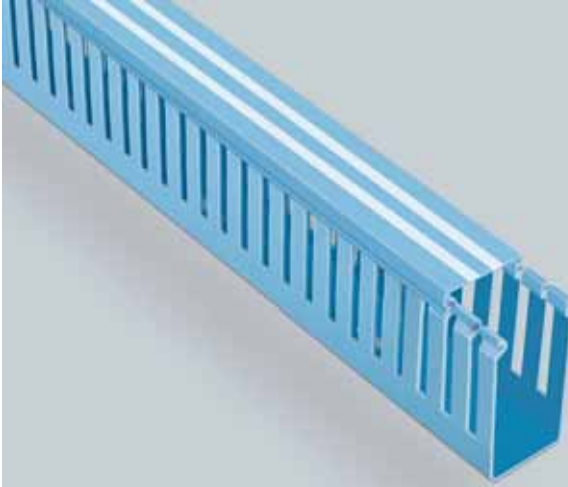
**25x40****Mavi**  
Blue

Ürün Kodu	Product Code	001 005 025040 20 13
Ambalaj Şekli	Packing Type	Kutu - Box
Adet / m	Quantity / m	80 m
Ağırlık	Weight	23,665 kg
m <sup>3</sup> /	Volume	0.0992

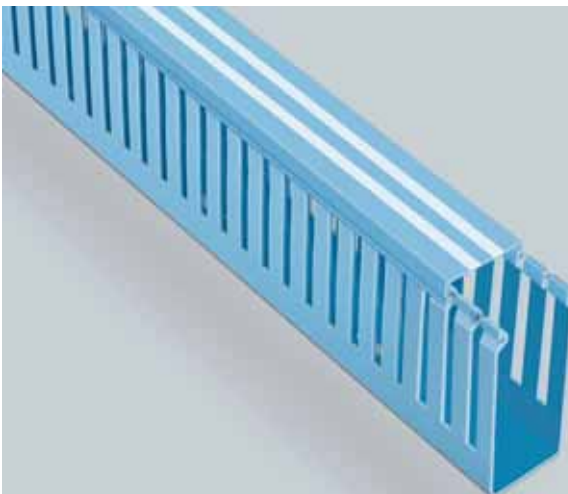
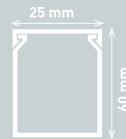
**25x60****Mavi**  
Blue

Ürün Kodu	Product Code	001 005 025060 20 13
Ambalaj Şekli	Packing Type	Kutu - Box
Adet / m	Quantity / m	80 m
Ağırlık	Weight	33.51 kg
m <sup>3</sup> /	Volume	0.14392

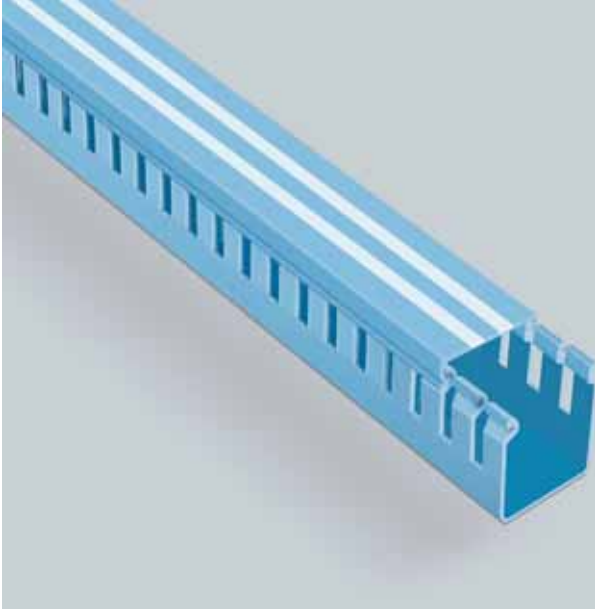
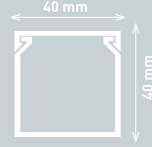
**40x40****Mavi**  
Blue

Ürün Kodu	Product Code	001 005 040040 20 13
Ambalaj Şekli	Packing Type	Kutu - Box
Adet / m	Quantity / m	50 m
Ağırlık	Weight	18.765 kg
m <sup>3</sup> /	Volume	0.0992

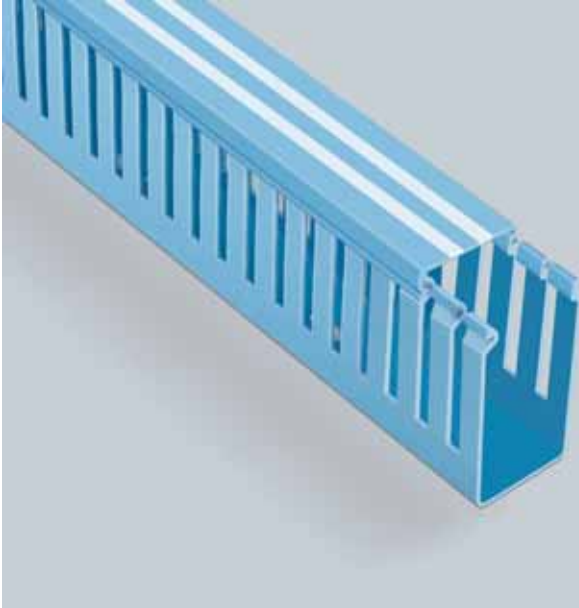
**40x60****Mavi**  
Blue

Ürün Kodu	Product Code	001 005 040060 20 13
Ambalaj Şekli	Packing Type	Kutu - Box
Adet / m	Quantity / m	48 m
Ağırlık	Weight	23.11 kg
m <sup>3</sup> /	Volume	0.1439

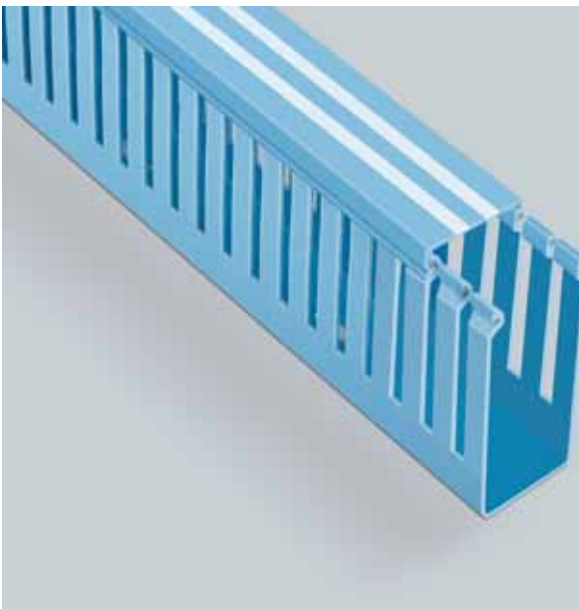
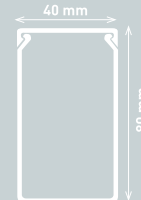
**40x80****Mavi**  
Blue

Ürün Kodu	Product Code	001 005 040080 20 13
Ambalaj Şekli	Packing Type	Kutu - Box
Adet / m	Quantity / m	36 m
Ağırlık	Weight	20.23 kg
m <sup>3</sup> /	Volume	0.14393

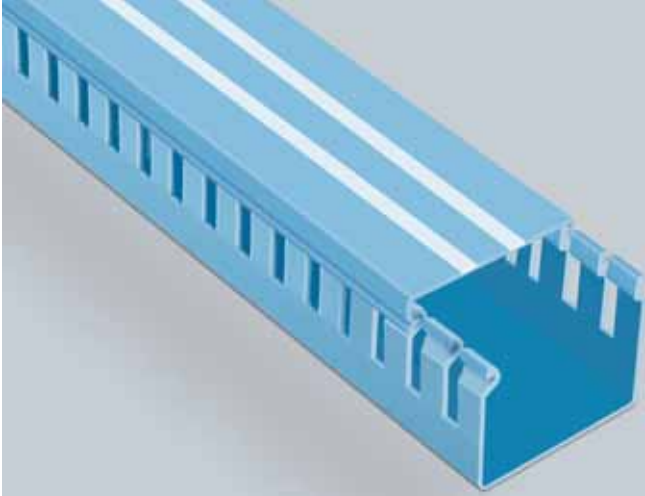
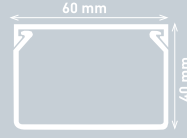

**60x40****Mavi**  
Blue

Ürün Kodu	Product Code	001 005 060040 20 13
Ambalaj Şekli	Packing Type	Kutu - Box
Adet / m	Quantity / m	48 m
Ağırlık	Weight	25.51 kg
m <sup>3</sup> /	Volume	0.1439

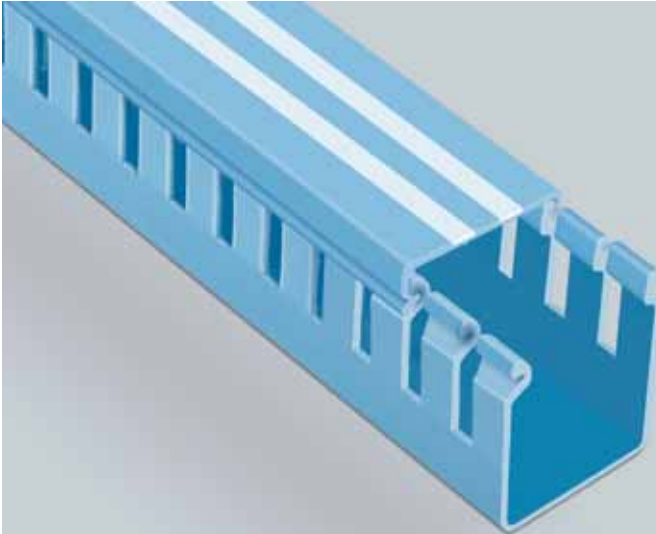
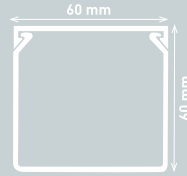
**60x60****Mavi**  
Blue

Ürün Kodu	Product Code	001 005 060060 20 13
Ambalaj Şekli	Packing Type	Kutu - Box
Adet / m	Quantity / m	32 m
Ağırlık	Weight	19.11 kg
m <sup>3</sup> /	Volume	0.1439



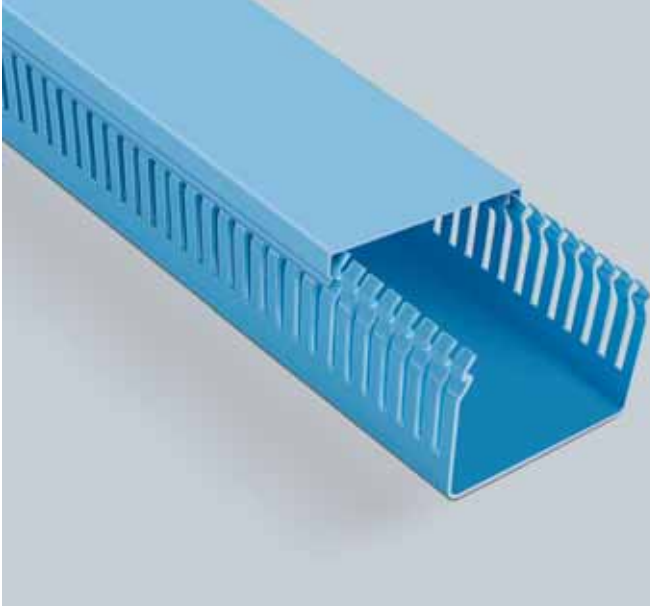
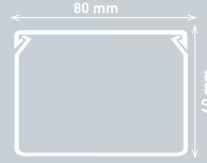

**80x60****Mavi**  
Blue

Ürün Kodu	Product Code	001 005 080060 20 13
Ambalaj Şekli	Packing Type	Kutu - Box
Adet / m	Quantity / m	24 m
Ağırlık	Weight	16.63 kg
m <sup>3</sup> /	Volume	0.1439

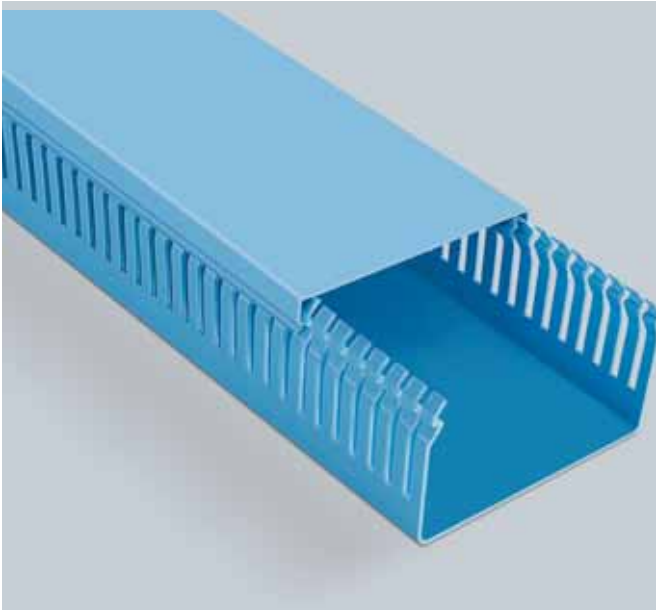
**100x60****Mavi**  
Blue

Ürün Kodu	Product Code	001 005 100060 20 13
Ambalaj Şekli	Packing Type	Kutu - Box
Adet / m	Quantity / m	16 m
Ağırlık	Weight	14.31 kg
m <sup>3</sup> /	Volume	0.1439

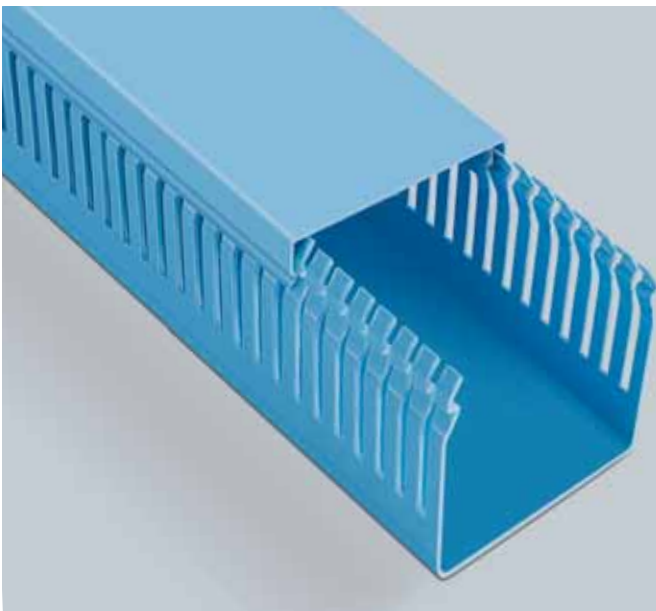
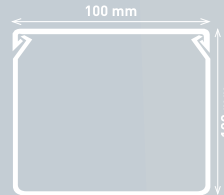
**100x100****Mavi**  
Blue

Ürün Kodu	Product Code	001 005 100100 20 13
Ambalaj Şekli	Packing Type	Kutu - Box
Adet / m	Quantity / m	8 m
Ağırlık	Weight	10.55 kg
m <sup>3</sup> /	Volume	0.1439

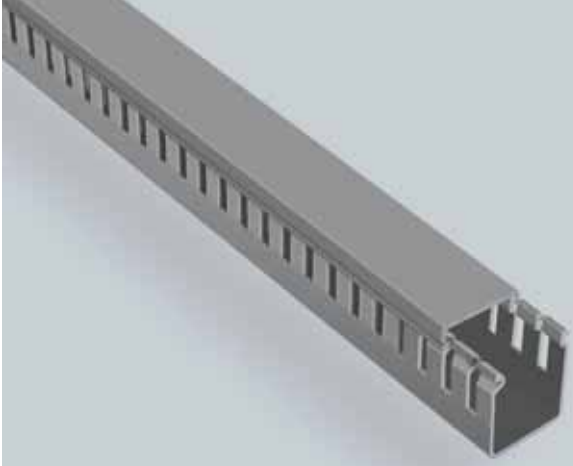
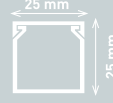
**25x25****Gri**  
Grey

Ürün Kodu	Product Code	001 005 025025 20 17
Ambalaj Şekli	Packing Type	Kutu - Box
Adet / m	Quantity / m	128 m
Ağırlık	Weight	26.865 kg
m <sup>3</sup> /	Volume	0.0992

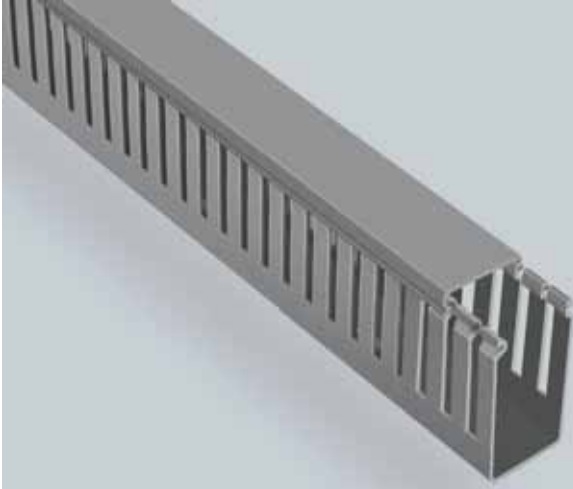
**25x40****Gri**  
Grey

Ürün Kodu	Product Code	001 005 025040 20 17
Ambalaj Şekli	Packing Type	Kutu - Box
Adet / m	Quantity / m	80 m
Ağırlık	Weight	23,665 kg
m <sup>3</sup> /	Volume	0.0992

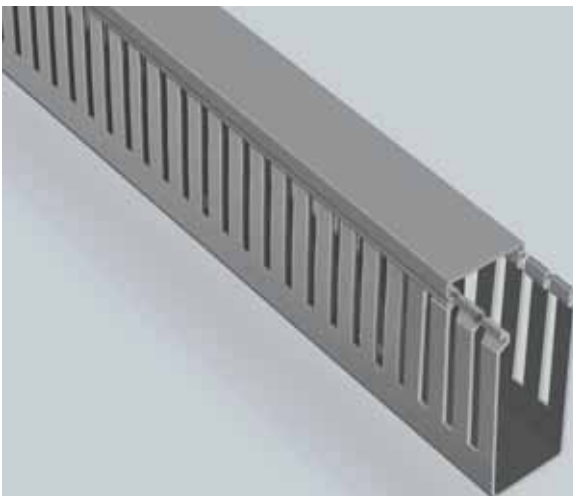
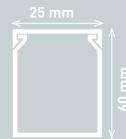
**25x60****Gri**  
Grey

Ürün Kodu	Product Code	001 005 025060 20 17
Ambalaj Şekli	Packing Type	Kutu - Box
Adet / m	Quantity / m	80 m
Ağırlık	Weight	33.51 kg
m <sup>3</sup> /	Volume	0.14392

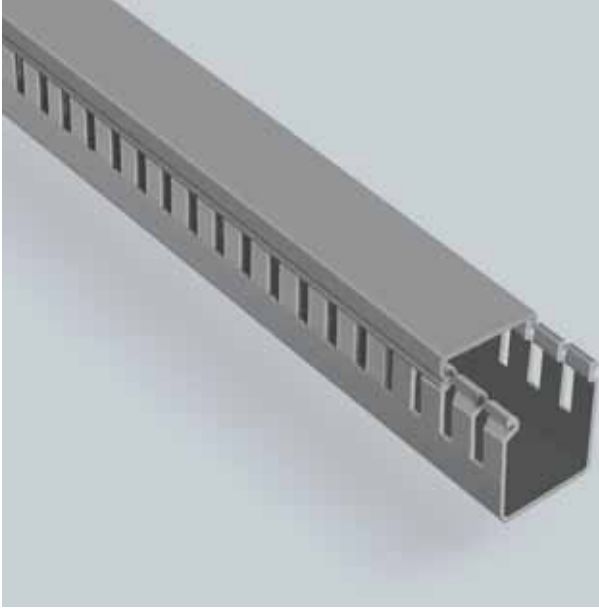
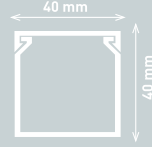
**40x40****Gri**  
Grey

Ürün Kodu	Product Code	001 005 040040 20 17
Ambalaj Şekli	Packing Type	Kutu - Box
Adet / m	Quantity / m	50 m
Ağırlık	Weight	18.765 kg
m <sup>3</sup> /	Volume	0.0992

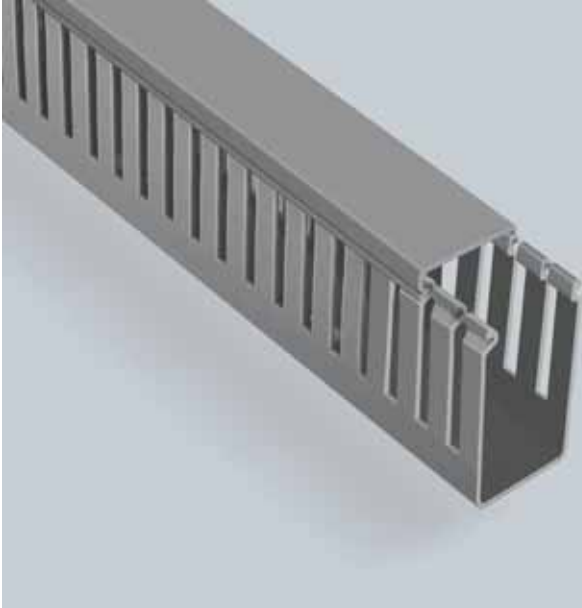
**40x60****Gri**  
Grey

Ürün Kodu	Product Code	001 005 040060 20 17
Ambalaj Şekli	Packing Type	Kutu - Box
Adet / m	Quantity / m	48 m
Ağırlık	Weight	23.11 kg
m <sup>3</sup> /	Volume	0.1439

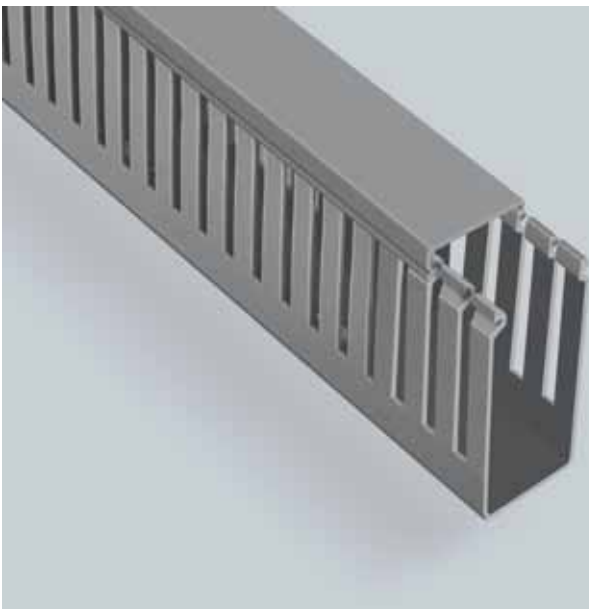
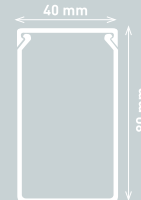
**40x80****Gri**  
Grey

Ürün Kodu	Product Code	001 005 040080 20 17
Ambalaj Şekli	Packing Type	Kutu - Box
Adet / m	Quantity / m	36 m
Ağırlık	Weight	20.23 kg
m <sup>3</sup> /	Volume	0.14393

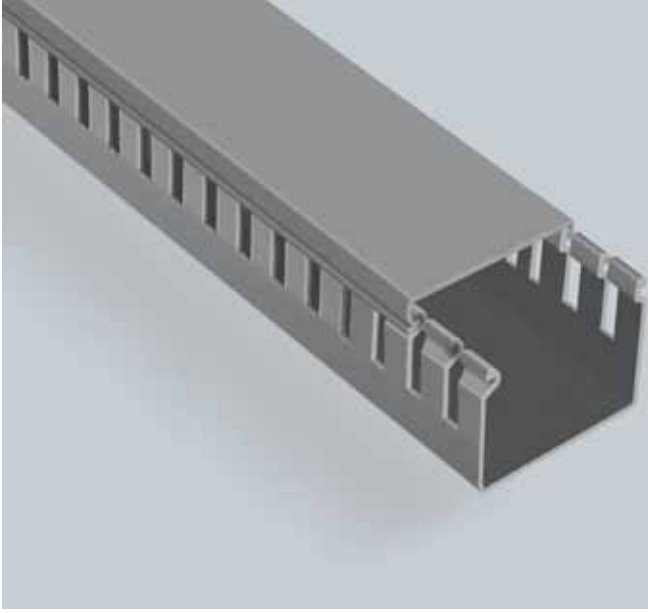
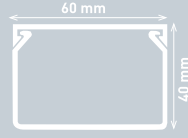
**60x40****Gri**  
Grey

Ürün Kodu	Product Code	001 005 060040 20 17
Ambalaj Şekli	Packing Type	Kutu - Box
Adet / m	Quantity / m	48 m
Ağırlık	Weight	25.51 kg
m <sup>3</sup> /	Volume	0.1439

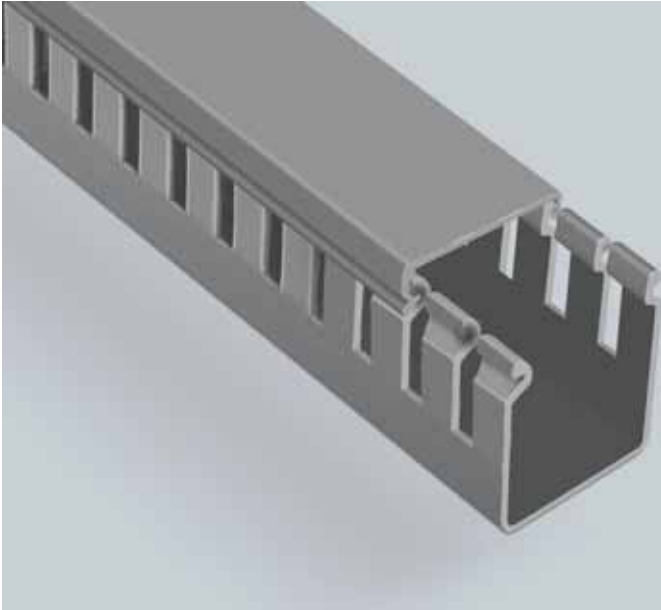
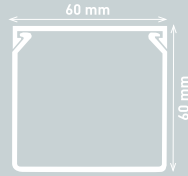
**60x60****Gri**  
Grey

Ürün Kodu	Product Code	001 005 060060 20 17
Ambalaj Şekli	Packing Type	Kutu - Box
Adet / m	Quantity / m	32 m
Ağırlık	Weight	19.11 kg
m <sup>3</sup> /	Volume	0.1439

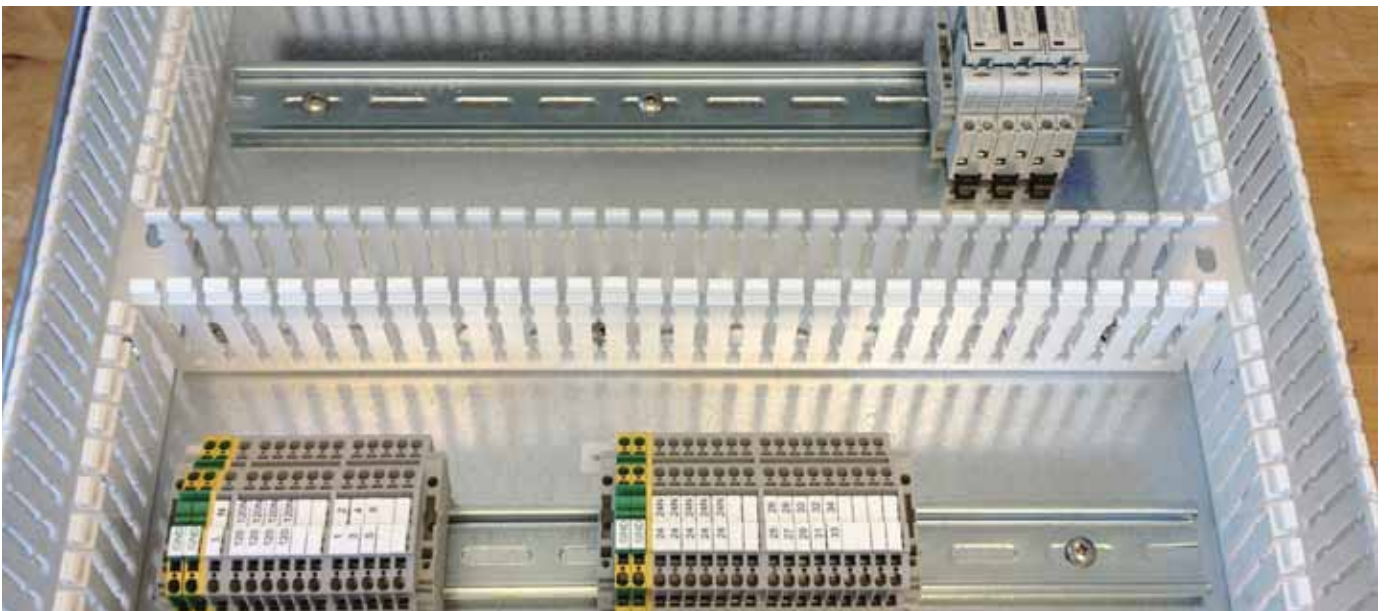

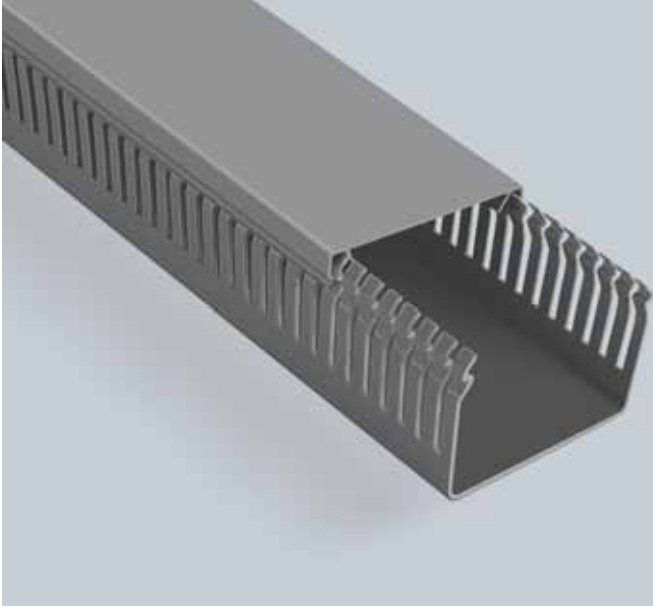
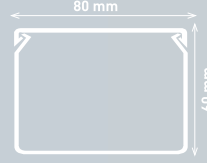
**80x60****Gri**  
Grey

Ürün Kodu	Product Code	001 005 080060 20 17
Ambalaj Şekli	Packing Type	Kutu - Box
Adet / m	Quantity / m	24 m
Ağırlık	Weight	16.63 kg
m <sup>3</sup> /	Volume	0.1439

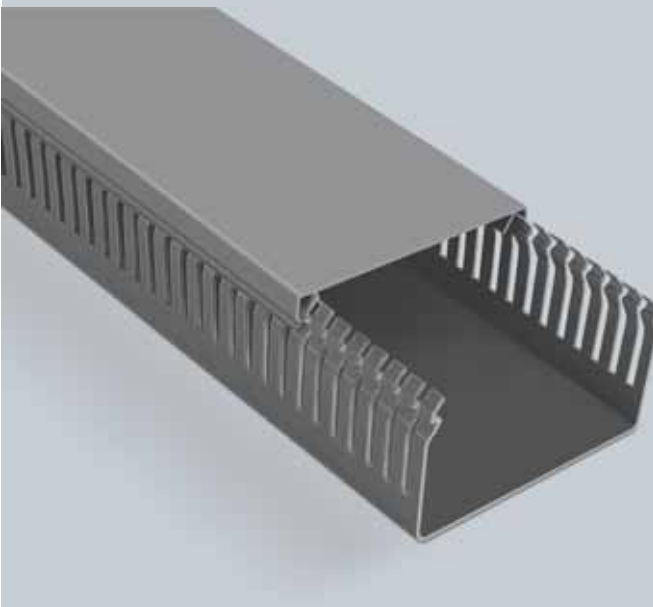
**100x60****Gri**  
Grey

Ürün Kodu	Product Code	001 005 100060 20 17
Ambalaj Şekli	Packing Type	Kutu - Box
Adet / m	Quantity / m	16 m
Ağırlık	Weight	14.31 kg
m <sup>3</sup> /	Volume	0.1439

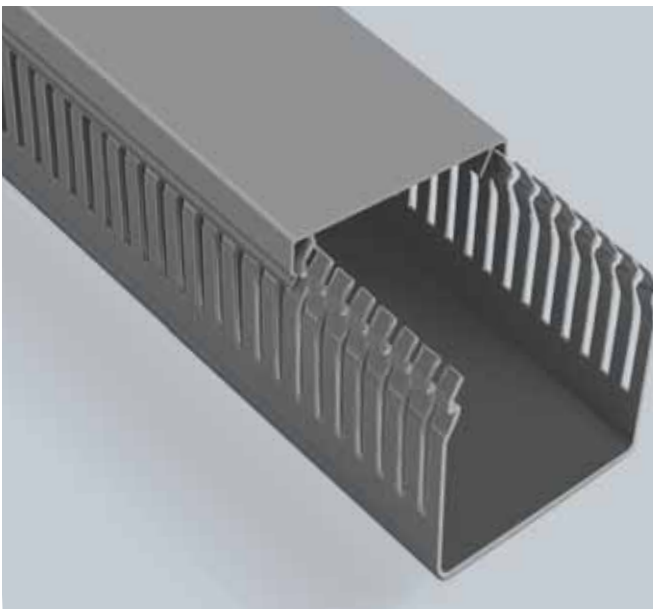
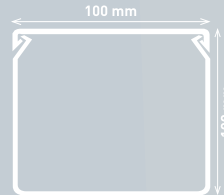
**100x100****Gri**  
Grey

Ürün Kodu	Product Code	001 005 100100 20 17
Ambalaj Şekli	Packing Type	Kutu - Box
Adet / m	Quantity / m	8 m
Ağırlık	Weight	10.55 kg
m <sup>3</sup> /	Volume	0.1439